

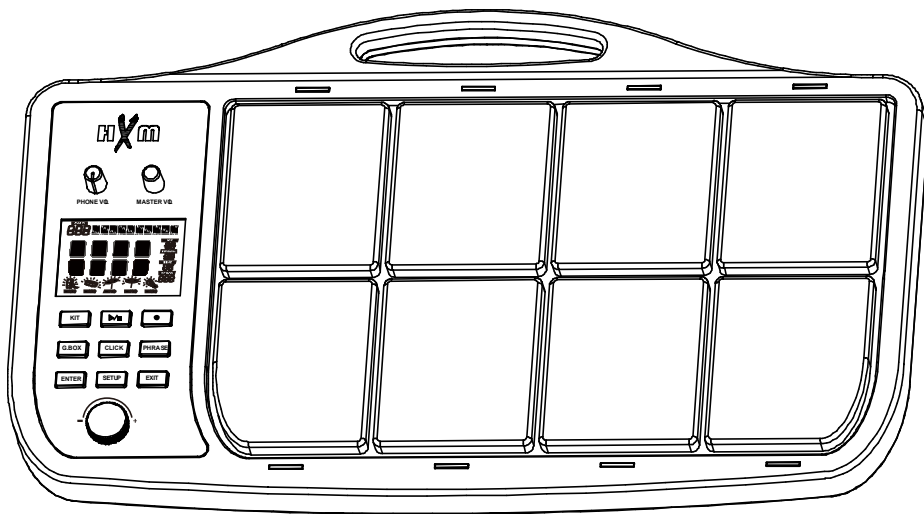

# HDP-1 DIGITAL DRUM

## USER'S MANUAL



## CAUTION

### CAUTION

Any changes or modifications in construction of this device which are not expressly approved by the party responsible for compliance could void the user's authority to operate the equipment.

### WARNING

When using electrical products, basic safety precautions should always be followed, including the following:

NOTE: This equipment has been tested and found to comply with the limits for a Class B digital device, pursuant to Part 15 of the FCC Rules.

Also, this equipment has been tested and found to comply with the limits for following standard:

EN55022-2006

EN55024:1998/+A1:2001/+A2:2003

EN55013:2001/+A1:2003/+A3:2006

EN55020:2007

EN61000-3-2:2006

EN61000-3-3:1995/+A1:2001/+A2:2003

These limits are designed to provide reasonable protection against harmful interference in a residential installation. This equipment generates, uses, and can radiate radio frequency energy and, if not installed and used in accordance with the instructions, may cause harmful interference to radio communications. However, there is no guarantee that interference will not occur in a particular installation. If this equipment does cause harmful interference to radio or television reception, which can be determined by turning the equipment off and on, the user is encouraged to try to correct the interference by one or more of the following measures:

- Reorient or relocate the receiving antenna.
- Increase the separation between the equipment and receiver.
- Connect the equipment into an outlet on a circuit different from that to which the receiver is connected.
- Consult the dealer or an experienced radio/TV technician for help.

## TAKING CARE OF YOUR DRUM



**DO NOT ATTEMPT TO OPEN THE UNIT OR MAKE ANY CHANGE IN THE CIRCUITS OR PARTS OF THE UNIT.**

### SERVICE AND MODIFICATION

This product should be serviced by qualified service personnel when,

- ♦ the power supply cord or the plug of the adaptor has been damaged,
- ♦ liquid has been spattered into the unit or it has been exposed to rain,
- ♦ the instrument does not appear to operate normally or exhibits a marked change in performance,
- ♦ the instrument has been dropped or the cabinet has been damaged.

### HANDLING AND TRANSPORT

- ♦ Never apply excessive force to the controls, connectors, pads or other parts of the instrument.
- ♦ Always unplug cables by gripping the plug firmly, not by pulling on the cable.
- ♦ Physical shocks caused by dropping, bumping, or placing heavy objects on the instrument can result in scratches and/or more serious damage.
- ♦ Carefully check the amplifier volume control before stating to play. Excessive volume can cause permanent hearing loss.

### CLEANING

- ♦ Clean the unit with a dry or light-wet soft cloth. Do not use paint thinner or petrochemical based polishes.

### LOCATION

Do not expose the drum to the following conditions to avoid deformation, discoloration, or more serious damage,

- direct sunlight (near a window),
- high temperatures (near a heat source, outside, or in a car during the daytime),
- rain or excessive humidity,
- excessive dust,
- strong vibration.
- ♦ The unit shall not be exposed to dripping or splashing and no objects filled with liquids, such as vases, shall be placed on the unit.
- ♦ The drum contains digital circuitry and may cause interference if placed too close to radio or television receivers. If interference occurs, move the drum further away from the affected equipment.

### POWER

- ♦ Only use attached power adaptor.
- ♦ Turn the power switch off when the drum is not in use.
- ♦ To avoid damage to the drum and other devices to which it is connected, turn the power switches of all related devices off prior to connection or disconnection of audio cables.
- ♦ Turn the power off if the main cable of the adaptor is damaged or the instrument is spattered with liquid.
- ♦ Do not switch the unit on and off in quick succession, this places an undue load on the electronic components.
- ♦ Unplug the AC power cord during an electrical storm.
- ♦ Avoid plugging the AC adaptor into the same AC outlet as appliances with high power consumption, such as electric heaters or ovens.

## CONTENTS TABLE

ABOUT MANUAL .....	7
INSTALLATION .....	8
CONTROL PANEL .....	9
BACK PANEL .....	10
PLAYING PAD .....	11
EXTERNAL TRIGGERING .....	12
DRUM KIT .....	13
KIT SELECTION .....	13
1. Basic Operation .....	13
2. Chain .....	13
3. Use Pedal to Select .....	14
4. External Kit Select .....	14
LAYER .....	15
GROOVEBOX .....	16
ENTER THE GROOVEBOX MODE .....	17
INITIALIZATION .....	17
PERFORMANCE .....	17
1. Play the Loop Parts .....	17
3. Play the Sequential Note .....	18
4. Play the Effect Sound .....	19
5. Play Complete Music .....	19
6. Change the G.BOX Number During the Playing .....	19
7. Synchronized Start .....	19
9. Adjust the Tempo .....	19
METRONOME .....	20
SOUND EFFECTS .....	21
PHRASE .....	22
ENTER THE RECORD MODE .....	22
RECORDER SETUP .....	23
1. Clear the Phrase .....	23
2. Record Mode .....	23
3. Select a Kit for Recording .....	24
4. Select Accompaniment .....	24
5. Measure Setting .....	25
6. Beat Setting .....	25
7. Set Tempo .....	25
8. Set Metronome Volume .....	26
9. Reverb Effect .....	26
10. Chorus Effect .....	26
11. Delay Effect .....	27
RECORDING .....	28

## CONTENTS TABLE

SAVE RECORDING .....	28
PLAYBACK CURRENT RECORDING .....	29
PLAY PHRASE .....	30
ERASE PHRASE .....	31
DRUM KIT EDIT .....	32
PAD KIT EDIT .....	33
1. Pad Kit Edit Preparing .....	33
2. Edit Parameters .....	33
(1) Layer .....	34
(2) Layer A Edit .....	34
2-1 Assign the Voice .....	34
2-2 Adjust Volume .....	34
2-3 Set Pan .....	35
2-4 Adjust Pitch .....	35
2-5 Set Reverb Level for Pad .....	35
2-6 Set Chorus/Delay Level for Pad .....	35
(3) Edit Layer B .....	36
(4) Complete the Pad Kit Editing .....	36
EXTERNAL KIT EDIT .....	37
1. External Edit Preparing .....	37
2. Edit Parameters .....	38
3. Complete the External Kit Editing .....	38
GLOBAL EDIT .....	39
1. Enter the Global Edit .....	39
2. Select Parameters .....	40
3. Edit Parameters .....	40
(1) Reverb Effect Edit .....	40
(2) Chorus Effect Edit .....	40
(3) Delay Effect Edit .....	41
4. Complete the Global Editing .....	41
KIT RESET .....	42
1. Enter the Kit reset .....	42
2. Reset the Kit .....	42
ADVANCED EDIT EDIT .....	43
PAD ADVANCED EDIT .....	44
1. Preparing .....	44
2. Edit Parameters .....	44
(1) Sensitivity .....	45
(2) Dynamic Range .....	45
(3) Mask Time .....	45
(4) Trigger Curve .....	45

## CONTENTS TABLE

(5) Cross Talk .....	46
3. Complete the Pad Advanced Edit .....	46
EXTERNAL ADVANCED EDIT .....	47
1. Preparing .....	47
2. Edit Parameters .....	47
3. Hi-Hat Control Pedal .....	48
4. Complete the External Instrument Advanced Edit .....	48
SYSTEM SETUP .....	49
GENERAL SETUP PROCEDURE .....	50
CHAIN .....	51
OVERALL SETTINGS .....	51
1 Equalizer .....	51
2 Master Volume .....	51
3 Master Tune .....	52
4 Pedal Switch Function .....	52
5 Pedal Effective Action .....	52
6 Local .....	52
7 Phrase Playing Mode .....	52
USER REVERB EFFECT .....	53
USER CHORUS EFFECT .....	54
USER DELAY EFFECT .....	54
USER EQUALIZER .....	55
RESET .....	56
MIDI & USB .....	57
KIT LIST .....	58
GROOVEBOX & ACCOMPANIMENT LIST .....	60
SOUND EFFECTS LIST .....	61
VOICE LIST .....	62
SPECIFICATIONS .....	69

## ABOUT MANUAL

The HDP-1 has many functions. They are introduced in respective chapters in the manual as listed below. The BASIC FUNCTION is recommended to read at first. Read the ADVANCED FUNCTION in case you need.

### BASIC FUNCTION

PLAYIN PAD and EXTERNAL TRIGGERING - The unit has 8 built-in pads and 5 external instruments can be connected. These chapters give you essential concept how to play them.

DRUM KIT - The unit has 80 preset pad kits and 5 external instrument kits. Each kit is a configuration of different voices assigned to each pad or instrument. Voices can be layered - two voices are assigned to a pad, they could be played in single, mixed or switch way depending on how hard striking the pad. The kit is very important concept of this drum.

GROOVEBOX - The GrooveBox provides an interesting and unique feature for your performance and entertainment. In this mode, the pad triggers musical elements including drum beat and other instrument obligato, effect sound and sequential notes. You can perform complete music by striking pads.

PHRASE- You can record your performance and save it as user phrases. Then, you can play it back. Two recording modes provide easy way to edit the recording in real time. Also, orchestration accompaniments can be merged into the phrase.

METRONOME - Built-in editable metronome is one of the useful utilities.

### ADVANCED FUNCTION

SOUND EFFECTS - The drum is equipped with DSP device that generates sound effects applying to the original sound to improve sound quality or change characteristic of the sound.

DRUM KIT EDIT - The unit provides powerful edit function allows you to edit preset kit, for instance, assign voice to the pad, set its volume, pitch and pan, establish your own layer mode etc.

ADVANCED EDIT – This function allows you to fine adjust behavior of the pad and external instrument such as sensitivity, dynamic range etc, though the manufacturer already did it. If necessary, read this chapter to learn how to do it to accommodate your taste.

SYSTEM SETUP - Setup function allows you to setup system parameters such as master tune, equalizer etc. You can also create custom sound effect module. These functions are for more professional requirement.

RESET - In case you want to recover factory default setting, the Reset function provide different way to do it.

### APPENDIX

It provides detailed information of Kit list, GrooveBox list, Accompaniment list etc.

**Please keep the Manual in hand or serve it in safe and convenient place for your frequent reference.**

## INSTALLATION

### Support Board Installation

This unit is for desk-top application. It can be also mounted on stand or drum kit rack with support board installed.

Align holes in support board and bottom of the unit, then insert four M6X12 screws and fasten it.

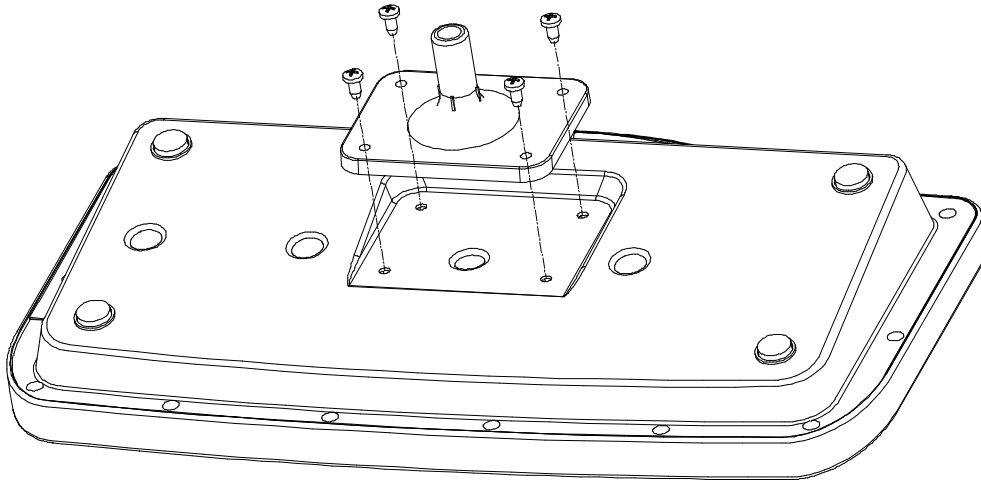

### Stick Storage

There are attached stick storage in the right side on the unit. Insert stick into the hole of the storage and push it until the stick hooks in and hear click sound.

Push it again, the stick will pop out.

 **Note:** Please use attached stick. Other sticks might have loose or stuck problem.

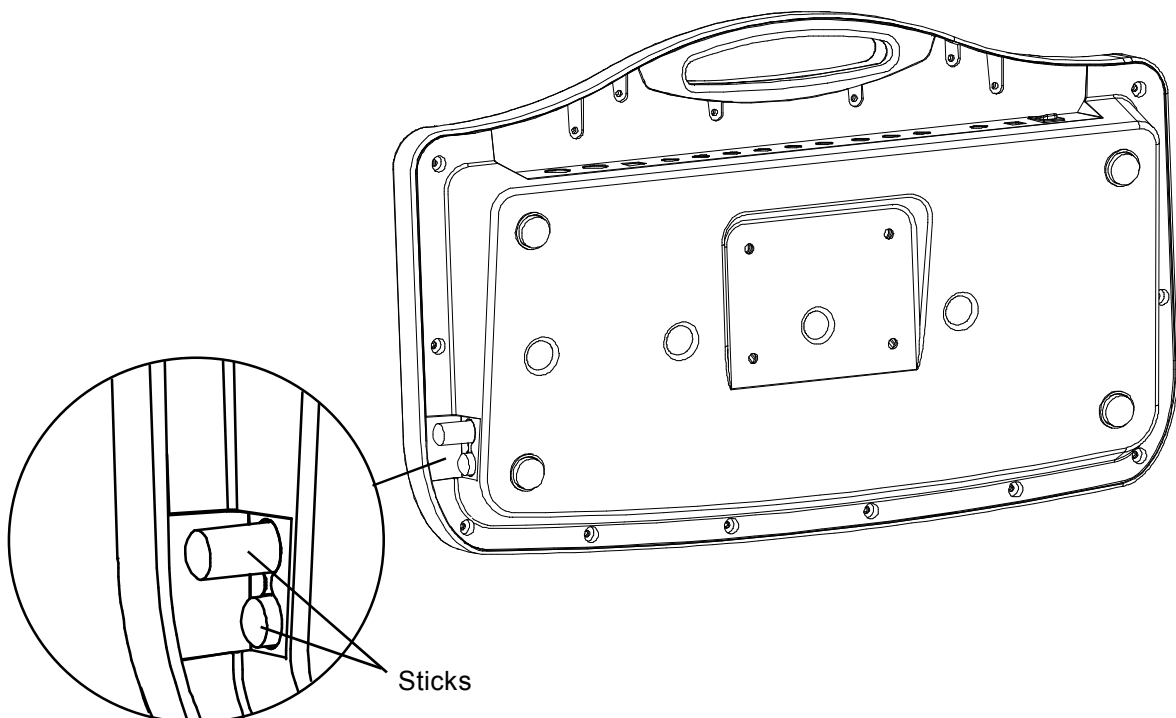



## CONTROL PANEL

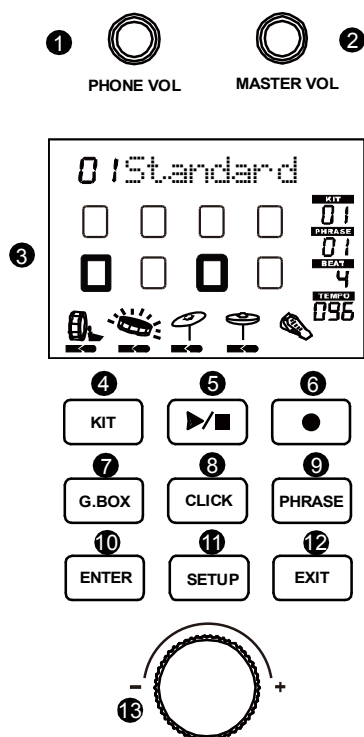

(1) **HEADPHONE VOL Knob:** Rotate the HEADPHONE VOL knob to adjust the headphone volume. Rotate the knob clockwise to increase the headphone volume and counter-clockwise to decrease the volume.

(2) **MASTER VOL Knob:** The Master Volume will affect both headphone volume and line out level. Rotate the MASTER VOL knob to change the master volume ranged 0 - 127. Rotate the knob clockwise to increase the volume and counter-clockwise to decrease the volume.

(3) **Display:** Information display such as Kit number and name, pad selection status etc. The display is back-lit LCD (Liquid Crystal Display) type.

(4) **KIT Button:** Press this button to enter the Kit selection window.

(5) **▶/■ Button:** Press the button to play or stop phrase or GrooveBox

 **Tip:** When switch pedal is plugged in and assigned to Start/Stop type, it'll function as the ▶/■ button.

(6) **● Buttons:** Press the button to record phrase.

(7) **G.BOX Button:** With the GrooveBox feature, the pad triggers musical elements including rhythm, chord, effect sound and sequencer notes. Press the button to enter the GrooveBox mode.

(8) **CLICK Button:** Metronome On/Off switch. Press and hold down this button for 2 seconds to engage metronome setup mode. When the metronome is engaged, indicator of the button will flash per current beat and tempo

(9) **PHRASE Button:** Phrase is a short piece of music can be recorded by user. It can be played back in loop. Press the button to enter the Phrase mode.

(10) **SETUP Button:** Enter the Setup mode to change many editable parameters

(11) **ENTER Button:** Confirm your choice or operating

(12) **EXIT Button:** Exit the current operation

(13) **DATA Knob:** Rotate the knob to change data for all operations.

 **Tip:** When switch pedal is plugged in and assigned to data plus/minus type, it'll function as the Data knob.

## BACK PANEL

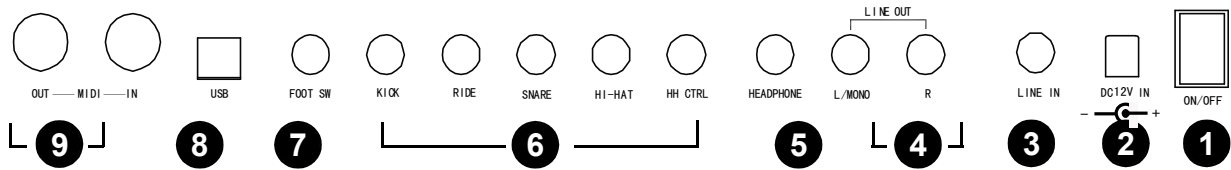

(1) **Power Switch:** Turn On/Off the sound module

 **Note:** When you turn the power off, do not turn it on immediately. Wait at least five seconds to turn the power on so that the electronic circuits can properly reset.

(2) **Power In Jack:** Plug in the DC cable of the attached adaptor

(3) **Line In Jack:** Line In stereo audio input jacks will mix the supplied signal with the internal drum sound. It can be used to hook up items such as CD players, MP3 player etc.

(4) **Line Out Jack:** There is no built-in speaker in the drum. Line Out stereo audio output supplies the drum output signal to external amplification, such as home stereo, PA system or other stand alone amplifiers. If you connect with external mono system, stereo/mono adapter is recommended.

(5) **Headphone Jack:** The drum has stereo headphone jack. You can play in total silence without disturbing others in the room by plugging a set of headphones into the sockets.

(6) **Expand Trigger Jacks:** Connect external Ride cymbal, Hi-Hat cymbal, Snare, Kick drum and Hi-Hat control pedal through these jacks.

(7) **Foot SW Jack:** Plug in a foot switch pedal. The pedal can be assigned to data plus/minus, Start/ Stop feature for easy operation by the pedal. The default setting is data plus/minus. Please refer to Overall Setting section of the <SYSTEM SETUP> Chapter for more information.

(8) **USB Jack:** The USB connector allows you to connect the drum directly to your computer's USB port. The USB interface is compatible with Windows XP, Windows Vista, Windows 7 and MAC OSx. The computer will recognize the drum as Audio Device.

(9) **MIDI In/Out Jack:** This drum contains MIDI in and MIDI output ports which allow communication with other products equipped with MIDI interfaces

## PLAYING PAD

### TURN ON THE POWER

- (1) Plug in the DC cable of the attached adaptor to the POWER jack.
- (2) Plug in the headphone to the Headphone jack. If you connect external audio device such as amplifier and speaker box, turn its volume to lower level.
- (3) Adjust volume of external audio device connected with the drum to lower level.
- (4) Press the POWER button.
- (5) Turn on external devices if it is connected.

### VOLUME

Strike pad and adjust the volume to proper level.

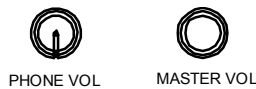

The Master Volume will affect both headphone volume and line out level. Rotate the MASTER VOL knob to change the master volume ranged 0 - 127. Rotate the knob clockwise to increase the volume and count-clockwise to decrease the volume. The display will show the volume and it'll blink. Press the ENTER button to confirm your setting, or after about 2 seconds without any operation, it will return to the previous window automatically.

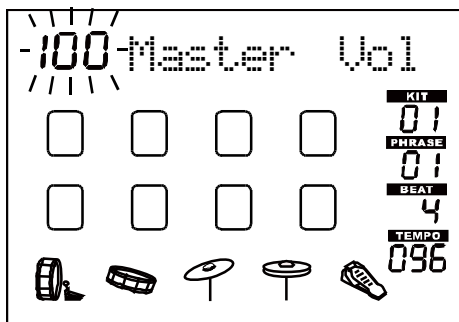

Rotate the PHONE VOL knob to control the headphone volume only.

### PLAYING PADS

All pads have striking strength sensitivity feature. Strike the pad harder to make higher volume and strike the pad softer to make lower volume.

 **Note:** The striking strength sensitivity feature is not applied to the pad 1-4 in the GrooveBox mode. Please refer to Chapter <GROOVEBOX> for details.

When strike a pad, its indicator will light up and corresponding block on the display will appear.

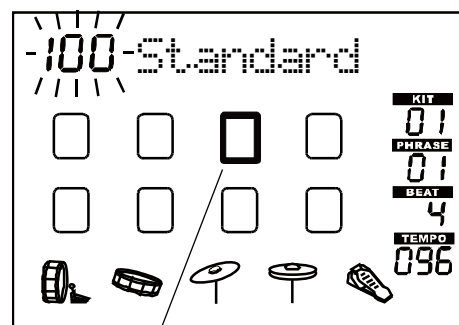

Strike Pad      Pad Indicator

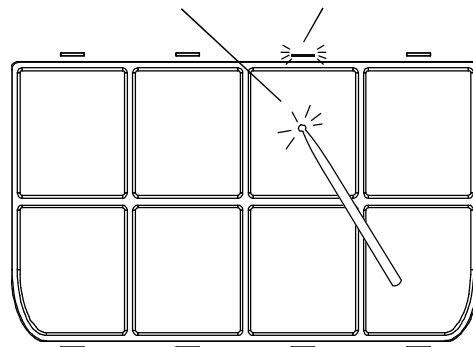

The pad could have layer feature. Strike the pad softer to sound a voice and strike the pad harder to sound another voice or mixed voices. Please refer to Chapter <Drum Kit> for details.

# EXTERNAL TRIGGERING

## EXTERNAL TRIGGERING

This unit can connect external instruments such as snare pad, ride cymbal, kick drum pad, Hi-Hat and Hi-Hat control pedal. The unit can be triggered by these external instruments.

Plug in the cable of the instrument to corresponding jack. Connection mark will appear underneath the external instrument icon on the display.

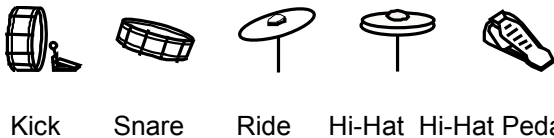

When play the external instrument, the external instrument icon will be triggered with ray symbol.

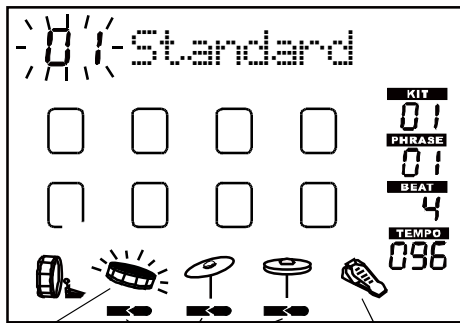

Struck instrument    Connection mark    External instrument not connected

### Playing Snare Drum

Strike the central position (head) of the pad to make head sound, strike the rim of the pad to make rim sound. There are two rim portions with different rim sound. Also, there is a mark on the pad to indicate the portion.

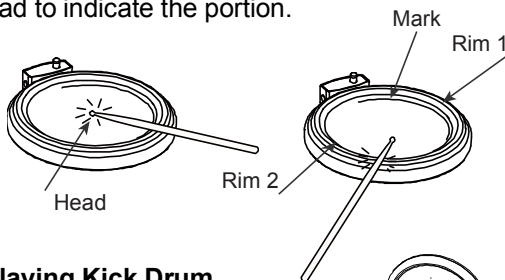

### Playing Kick Drum

Press the Kick drum pedal to make kick drum sound.

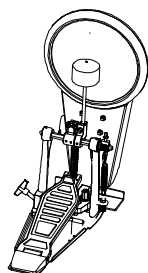

### Playing Cymbal

Strike the central position (bow) of the cymbal to make cymbal sound, strike the edge of the cymbal to make edge shot sound.

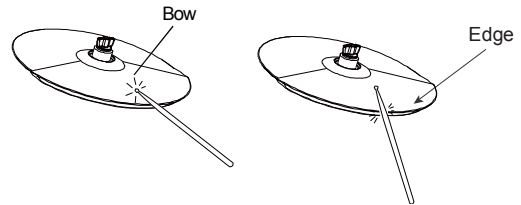

### Cymbal Choke

Strike the cymbal, its sound will sustain. Then squeeze the edge portion to mute the sound. Please note that the Hi-Hat has no choke feature.

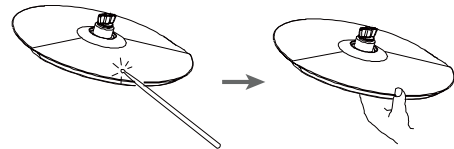

### Playing Cymbal Bell

Strike the bell at the large ride cymbal to make cymbal bell sound.

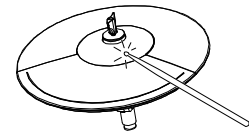

**Note:** This feature is available for the cymbal with bell only,

### Playing Hi-Hat

- (1) Strike the Hi-Hat pad without pressing the Hi-Hat control pedal to make open Hi-Hat sound.
- (2) Strike the Hi-Hat pad with fully pressing the Hi-Hat control pedal to make close Hi-Hat sound.
- (3) Strike the Hi-Hat pad while pressing the Hi-Hat control pedal gradually to make consecutive closed Hi-Hat sound.
- (4) Press the Hi-Hat pedal down quickly to make Hi-Hat pedal sound.

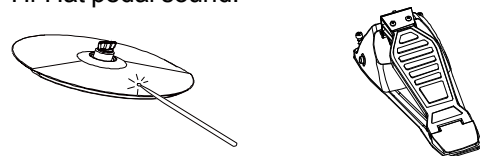

**Note:** Hi-Hat cymbal has no edge and choke features

**CONTACT YOUR VENDER TO PURCHASE EXTERNAL INSTRUMENT**

# DRUM KIT

The unit has 80 preset pad kits and 5 external instrument kits for your choice. Each kit is a configuration of different voices assigned to each pad or instrument.

The diagram below presents brief control flow of the kit selection. The following pages will give you detailed description.

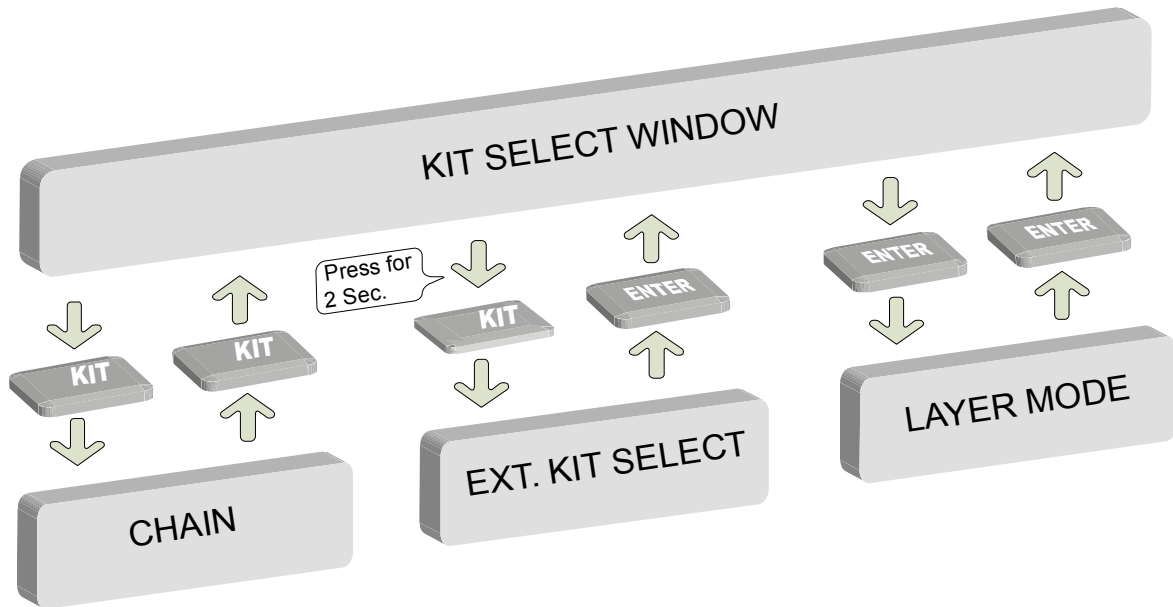

## KIT SELECTION

### 1. BASIC OPERATION

There are 80 preset pad kits for your choice. The pad kit is applied to 8 built-in pads. After power on, the pad kit selection window is engaged automatically while the KIT button indicator will light up. The kit number and its name will be shown. The kit number also appears in the right side of the display.

Rotate the Data knob to select a pad kit. Rotate the knob clockwise to increase the kit number and anticlockwise to decrease the kit number. All pad kits listed in the Appendix <KIT LIST> in the back of the manual.

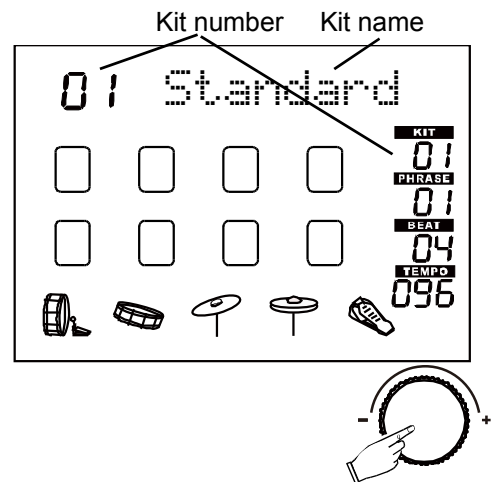

### 2. CHAIN

It is often to change the pad kit during the performance. The Chain feature provides an easy and fast way to change the kit. You can organize desired pad kits into a chain then call your favorite kit consecutively.

There are 10 pad kits can be stored in the chain. In the Kit Selection window, the KIT button functions as a toggle switch to select normal selection and Chain selection mode. Press the KIT button to engage the Chain mode. The Chain icon will appear and the Chain number with

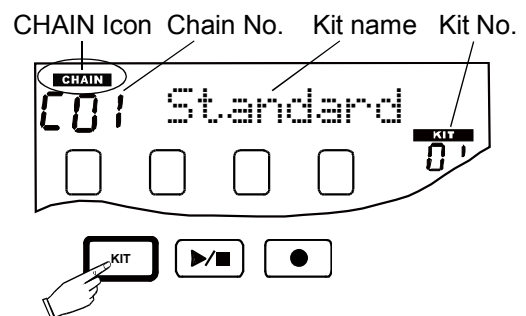

## DRUM KIT

prefix “C” and kit name will be shown on the top row of the screen. Its corresponding pad kit number will be shown in the KIT area in the right side of the display. Rotate the DATA knob to select Chain number..

Press the KIT button again to exit the Chain mode and convert to normal Kit Selection window.

 **Tip:** You can assign your favorite kits to chain. Please refer to the <SYSTEM SETUP> Chapter for details.

### 3. USE PEDAL TO SELECT

You could also use foot switch pedal to select kit or Chain number, if the pedal is connected. Press the pedal, the kit number will increase by one defaultly. You could set it for decreasing by one with the Setup function. Please refer to the <SYSTEM SETUP> Chapter in the manual for details.

 **Tip:** You can use the pedal as the Data Knob in many other cases.

### 4. EXTERNAL KIT SELECT

When external instruments are connected, they are played in voice assigned to the external kit.

Press and hold down the KIT button for 2 seconds, the external kit number with “E” prefix will be shown. Default external kit is E1.

Rotate the Data knob to select an external kit. There are 5 external kits can be selected.

Press the ENTER button to confirm and exit.

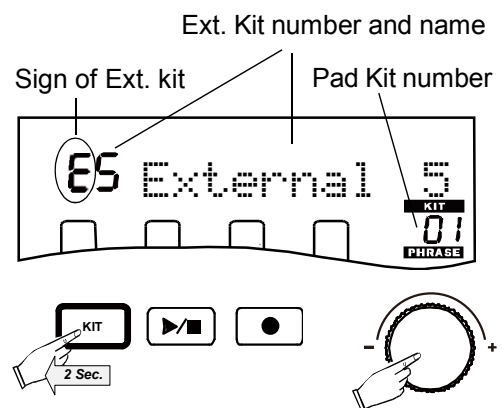
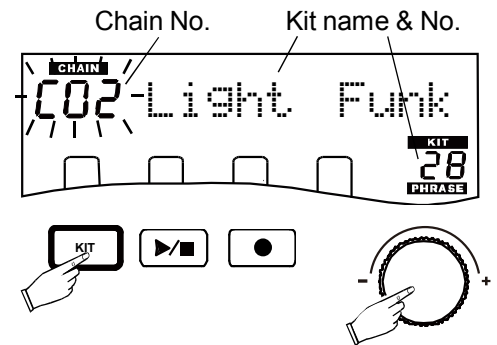

# DRUM KIT

## LAYER

In this mode, two voices are assigned to each pad. The sound layering depends on how hard you strike the pad. This feature allows you have more expressive performance. There are 5 layering types determining how voices of Layer A and Layer B are arranged.

**Switch** - you'll hear voice A when strike softer and hear voice B when strike harder than the Layer Point.

**Mix** - You'll hear voice A when strike the pad softer and voice B will be added when strike harder than the Layer Point.

**Fade** - You'll hear voice A when strike the pad softer and voice B will be added gradually when strike harder than the Layer Point. The stronger the striking, the more the voice B will be added.

**X.Fade** - This is essentially the same as Fade, but Voice A will fade when strike harder than the Layer Point. The harder the striking, the more fades.

**Off** - Layer feature off. Voice A only

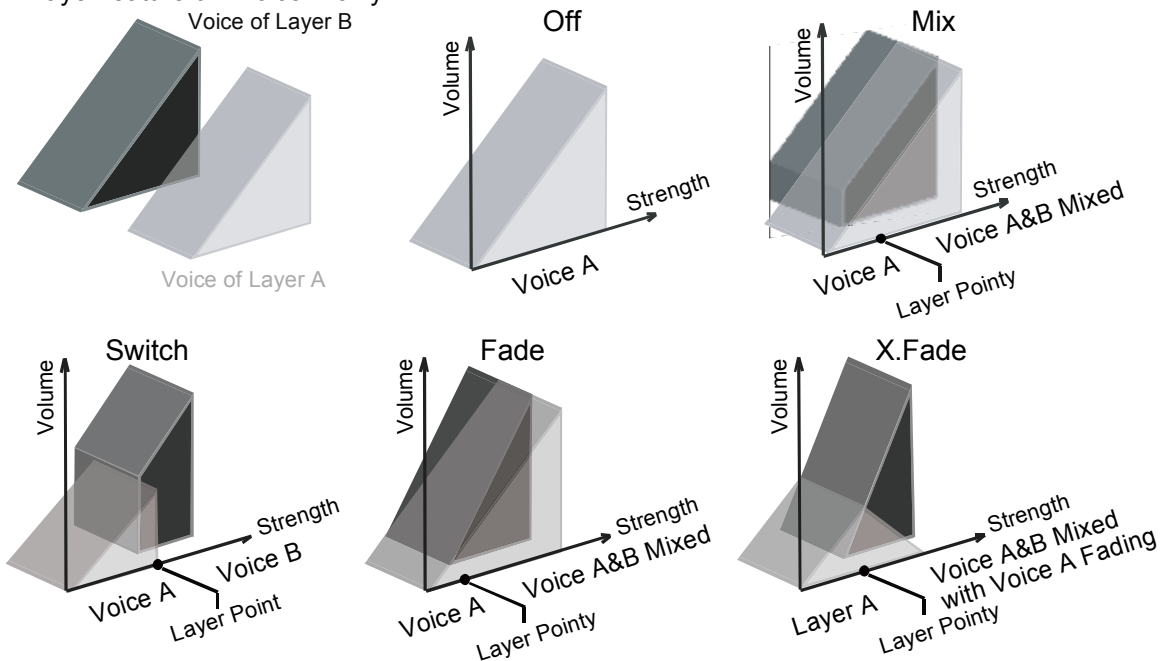

In the kit select window, press the ENTER buttons to watch the current layering status. The layer mode mark A, b or L will be added in front of the kit number and blink. "A" represents no-layering but voice A only, "b" represents no-layering but voice B only and "L" represents Layer mode is engaged. Rotate the Data knob to change the mode. Press the ENTER button again to confirm and back to normal kit number display.

Layering Mode mark

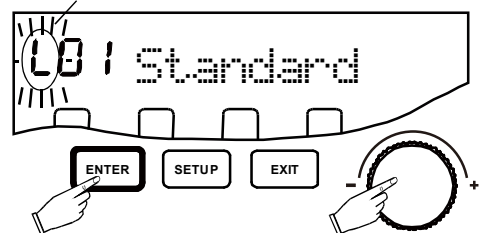

**Note:**

1. Not all kits preset layering feature. Please refer to <KIT LIST> in the back of the manual. If the kit is no layering preset,
2. Not all kits preset layering feature. Please refer to <KIT LIST> in the back of the manual. If the kit is no layering preset , i.e. the layer type is Off, it always show A when rotate the Data knob. If the kit is preset with layering mode, the default status is L.
3. The layer mode change here is tempoary. When you re-select this kit, the layerup mode will recover to its default setting.



**Tip:** You can change layer preset and reserve it. Please refer to the <DRUM KIT EDIT> Chapter.

# GROOVEBOX

The GrooveBox provides an interesting and unique feature for your performance and entertainment. When you play pad, it triggers GrooveBox music but not simply pad kit sound.

The GrooveBox music composed of loop playing parts including drum beat and three obligatos and single voice parts including effect sound and sequential notes. Each loop part and sequences has 4 variations A to D.

Combining with these preset elements; you can perform complete music with many varieties by striking pads.

There are 20 GrooveBox musics built-in for your choice. Please refer to the GrooveBox List in the back of this manual for details.

In this performance mode, 8 pads are divided to two sections. 4 upper pads marked 1 - 4 are for loop parts triggering. 4 lower pads marked 5 - 8 are for single Voice triggering.

The diagram below presents brief control flow of GrooveBox operation. The following pages will give you detailed description.

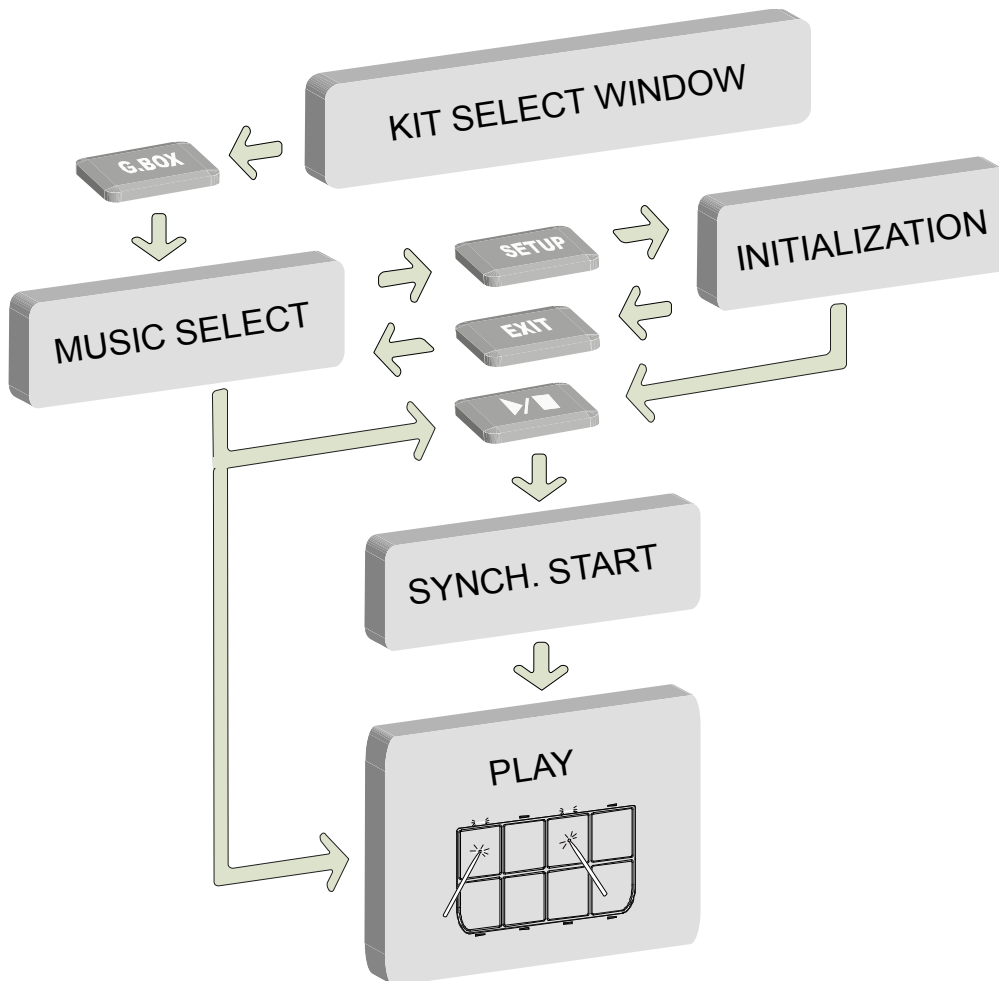
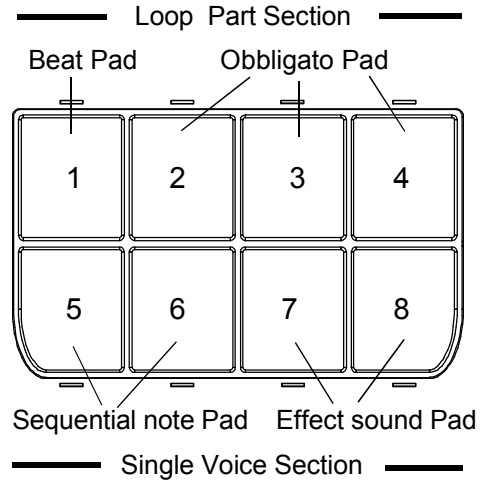



# GROOVEBOX

## ENTER THE GROOVEBOX MODE

In the kit select window, press the G.BOX button and its indicator will light up. The name of GrooveBox music and its index number with prefix "b" will be shown. The tempo and beat of it will appear on the right side of the screen. When the music number is blinking, rotate the Data knob to select GrooveBox music.

Pressing the EXIT or KIT button to exit the GrooveBox and turn to Kit window.

Sign of G.Box Music number Music name

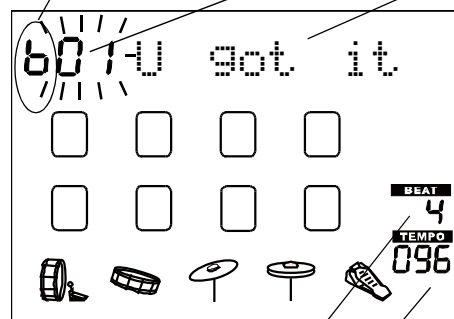



Beat and tempo of the music

## INITIALIZATION

The default variation is A for all pads. If you want, you can choose any variation as an initial variation to start play. In the G.Box music select window, press the SETUP button, the music name will be replaced by blinking variation code A, B, C, D. Rotate the Date knob to change variation together. Or, you can hit particular pad soft to change its variation individually. Hit the pad hard to disable it while its variation code will stop blink. Strike the pad again to enable the pad.

Press the EXIT button to exit the initialization and back to the music select window.

 **Tip:** The "disable" feature is useful for Synchronized start mode.

 **Note:** Rotating the Data knob cannot change the variation for disabled pad.

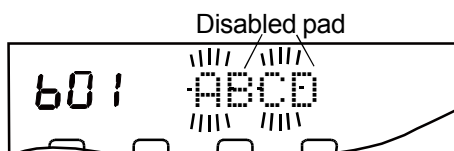
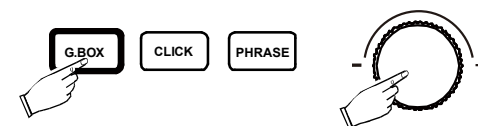

## PERFORMANCE

### 1. PLAY THE LOOP PARTS

Start playing loop parts by strike the Pad 1 to play beat, strike the Pad 2 - 4 to play obbligato 1 - 3.

Its indicator will light up and corresponding block on the display will appear. The music name will be replaced by variation code and the code for working pad will blink.

Then, once you strike the pad soft, it'll change to the next variation. The variation change will occur from the next note and keep the beat and measure consecutively. Strike the pad hard to mute it and the block of this pad will disappear, its variation code will stop blink as well.

## GROOVEBOX

The measure count and beat will be displayed in real time. Even if you mute all parts, the count keeps running.

Rotate the Data Knob, the variation of working pads will change at same time based on the its current variation.

During the playing, you can add another part by striking relevant triggering pad. New part will be inserted at the next note of the current obligato or beat and keep the measure and beat consecutively. Please note that the beat and the obligato are totally synchronized.

Alternatively, you don't need to stop beat and obligato parts by hitting pads hard separately. Press the ►/■ button to stop all parts playing and the beat and measure count will disappear. Press the ►/■ button again to start play all beat and obligato parts from the first measure, which was effective before the stop.

### 2. PLAY THE SEQUENTIAL NOTE

Each G.Box music has sequence part. You can control when its notes sound. When you strike pad 5 or 6, notes will be triggered sequentially. The variation code of the pad 5 is the same as pad 1 and the variation code of the pad 6 is the same as pad 2.

The sequence is synchronized with beat and/or obligato in measure. Only notes in the same measure of the beat and/or obligato can be played. The triggering point is free within the measure, but If you strike the pad more times than the note number of this measure, the notes will repeat.

 **Tip:** You can play the sequence note any-time even if the beat/obligato are not really be played.

### 3. Play the Effect Sound

Strike the Pad 7 or 8 to trigger an effect sound immediately. Only a single sound is triggered once, therefore, you don't need to turn it off. Each effect sound part has several different sounds. Once you strike the pad, it'll change to the next sound.

 **Note:** In the GrooveBox mode, the pad 1 - 4 has no strength sensitivity feature. It is for triggering the beat and obligato only. The pad 5 - 8 has strength sensitivity feature, the harder the striking, the louder the volume.

 **Tip:** You can start two parts at same time by strike these pads simultaneously.

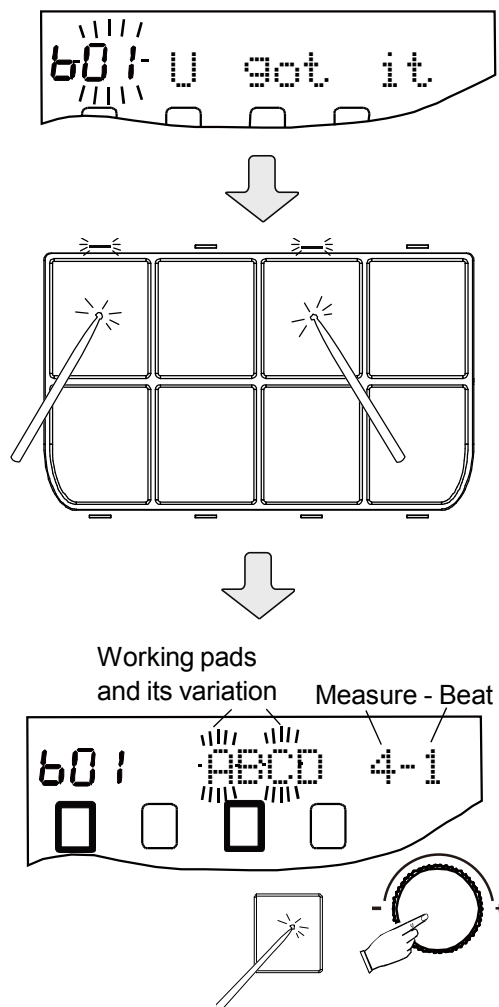

# GROOVEBOX

## 4. PLAY COMPLETE MUSIC

You can compose your music by arranging parts per your taste in the way described above. You can play pads randomly and could also get amazing results.

When external instrument is are connected, you can also play it together with the GrooveBox performance. If you want to change the External kit number, press and hold down the KIT button for 2 seconds, The external kit number will appear with "E" prefix and blink. Rotate the Data knob to change it then press the ENTER button to confirm.

## 5. CHANGE THE G.BOX NUMBER DURING THE PLAYING

you can change the GrooveBox by rotating the Data knob when all pads stopped by the ►/■ button.

## 6. SYNCHRONIZED START

After select the G.Box music, press the ►/■ button, all beat and obligato parts will start playing together per their initial variation and status setting.

In this way, you don't need to start beat and obligato parts by hitting pads.

 **Tip:** In the initializing window, you can enter the synchronized start directly by pressing the ►/■ button .

## 7. ADJUST THE TEMPO

The beat and obligato part share the same tempo. You can change the default tempo. Press and hold down the CLICK button for 2 seconds. The current tempo will blink in the right side of the display. Rotate the Data knob to change the tempo ranged 40 - 240 beat per minute. Press the ENTER button to confirm your setting and the tempo value will stop blink.

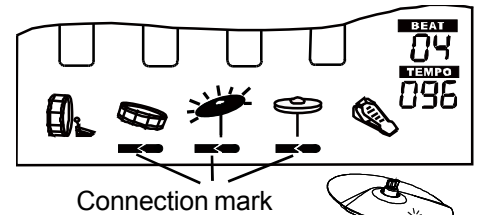

External kit number

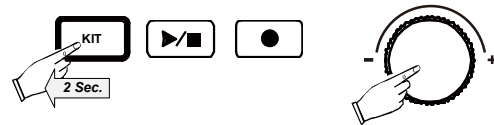
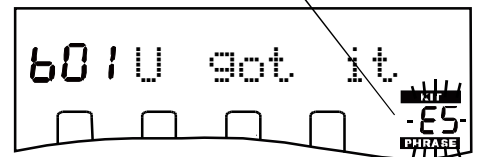

Change variations together

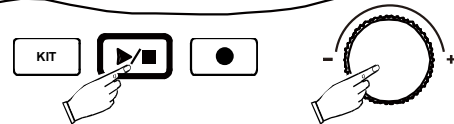
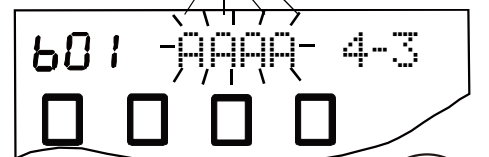

Adjust tempo

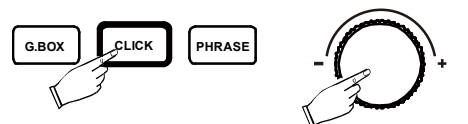
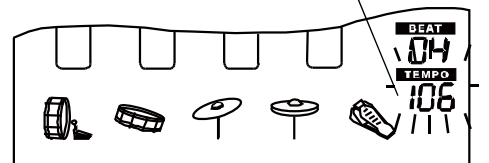

# METRONOME

Press the CLICK button, the metronome will start immediately. The metronome sound is louder at the first beat and lower for other beats. The CLICK indicator will flash per beat and tempo setting. The indicator will be lighter at the first beat. Press the CLICK button again to stop it.

Press and hold down the CLICK button for 2 seconds to setup the metronome; and the indicator will blink. The metronome will keep sounding and response to your setting in real time.

Use the Data knob to setup. After parameter setting, press the ENTER button to confirm your setting and turn to the next parameter setting.

Press the KIT button to exit the setting and back to the Kit Selection window.

Following parameters can be changed.

(1) Tempo\_- The current tempo will blink. Rotate the DATA knob to change the tempo ranged 40 - 240 beat per minute. The tempo will be also shown in the right side of the screen. The default tempo is 120.

(2) Beat\_- the current beat will blink. Rotate the DATA knob to change the beat ranged 2 - 12. The beat will also be shown in the right side of the screen. The default beat is 4.

(3) Volume\_- The current metronome volume will blink. Rotate the DATA knob to change it ranged 0 - 127.

 **Tip:** If you do not want to change the current parameter, press the ENTER button to skip it.

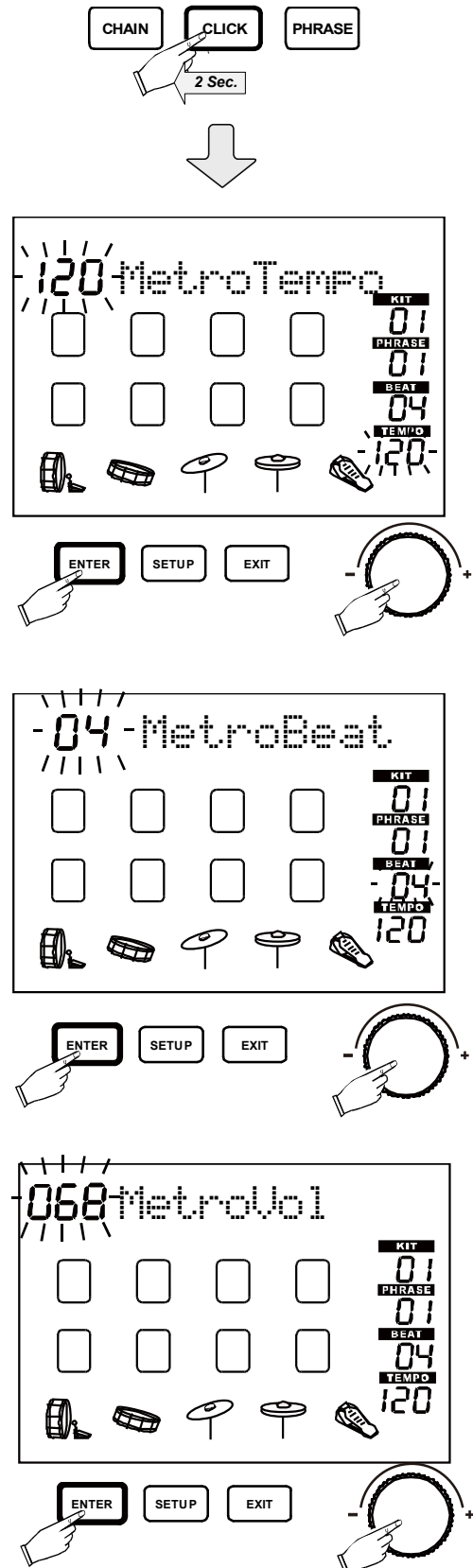

## SOUND EFFECTS

The drum is equipped with Professional Digital Signal Processor (DSP) that generates sound effects applying to the original sound to improve sound quality or change characteristic of the sound.

These effects are classified to three categories: Reverb, Chorus and Delay. You can choose one of the effect types from a category and enable/disable it respectively so that you can apply three kinds of the effect at same time in maximum.

These effects are applied to enter unit but not for individual pad or external instrument. The unit presets particular effects set for each drum kit, when you change the drum kit, the preset effect set will be bound with it, except that when you change the kit during phrase record or phrase playing the effect kit will stay on the original setting.

You can use the Kit Edit function to change the presetting for each kit such as switch On/Off the effect, change the effect type and its global level. Though effects are applied to enter unit globally, the drum provides utility to adjust effect level for each pad or external instrument, i.e. voice, separately. Please refer to the <DRUM KIT EDIT> Chapter for details.

You can create your own effects to fit your taste, or simply for fun, please refer to the <SYSTEM SETUP> Chapter for details.

### Reverb Effect

The unit has 26 reverb types preset.

Reverb effects simulate sound natural reflection from walls and ceilings of various halls, rooms. In addition, there are several other reverb effects such as Gated Reverb and plate.

- Gated Reverb: add ambience only while the original signal is still sounding. As soon as the signal falls below a threshold, the reverb is automatically cut off
- Plate: simulate plate type reverb with their tight, dense early reflections and sharp reverb buildup
- Echo: It is a reflection of sound, arriving at the listener some time after the direct sound.

### Chorus Effect

The unit has 22 chorus types preset.

Chorus effects thicken the sound or make one sound like many. There are many types of effects in this category:

- Chorus: An imitation of multiple sounds with the same timbre and pitch converge and are perceived as one.
- Phaser: It creates a sweeping effect. Its sound is similar to that of flanging.
- Flange: It combines two copies of the same sound, with the second delayed slightly, to produce a swirling effect.
- Tremolo: An imitation of reiteration of sound.

### Delay Effect Edit

The unit has 4 delay types preset.

Delay effect plays sound back after a period of time. You can add Delay effect to Chorus or Flange effect.

**Equalizer** is another kind of sound effect application.

It adjusts the tone of sound by strengthening or weakening the energy of specific frequency to achieve desired balance, for instance, to boost bass, brighten treble, moderate alto voice etc.

There are 8 types of built-in equalizer for your choice. You can create your own 4-band equalizer by the User Equalizer function, please refer to the <SYSTEM SETUP> Chapter for details.

The <SOUND EFFECTS LIST> in the back of the Manual presents all effect types for your reference.

# PHRASE

You can record your performance and save it as one of 30 user phrases. Then, you can play it back in loop and edit to make it perfect. There are 20 built-in orchestration accompaniments can be added to the phrase, styles of which include Pop, Hip-Hop, Electronic, R&B, Funk etc.

The diagram below presents major modules and brief control flow of the Phrase function. Following pages will give you detailed description.

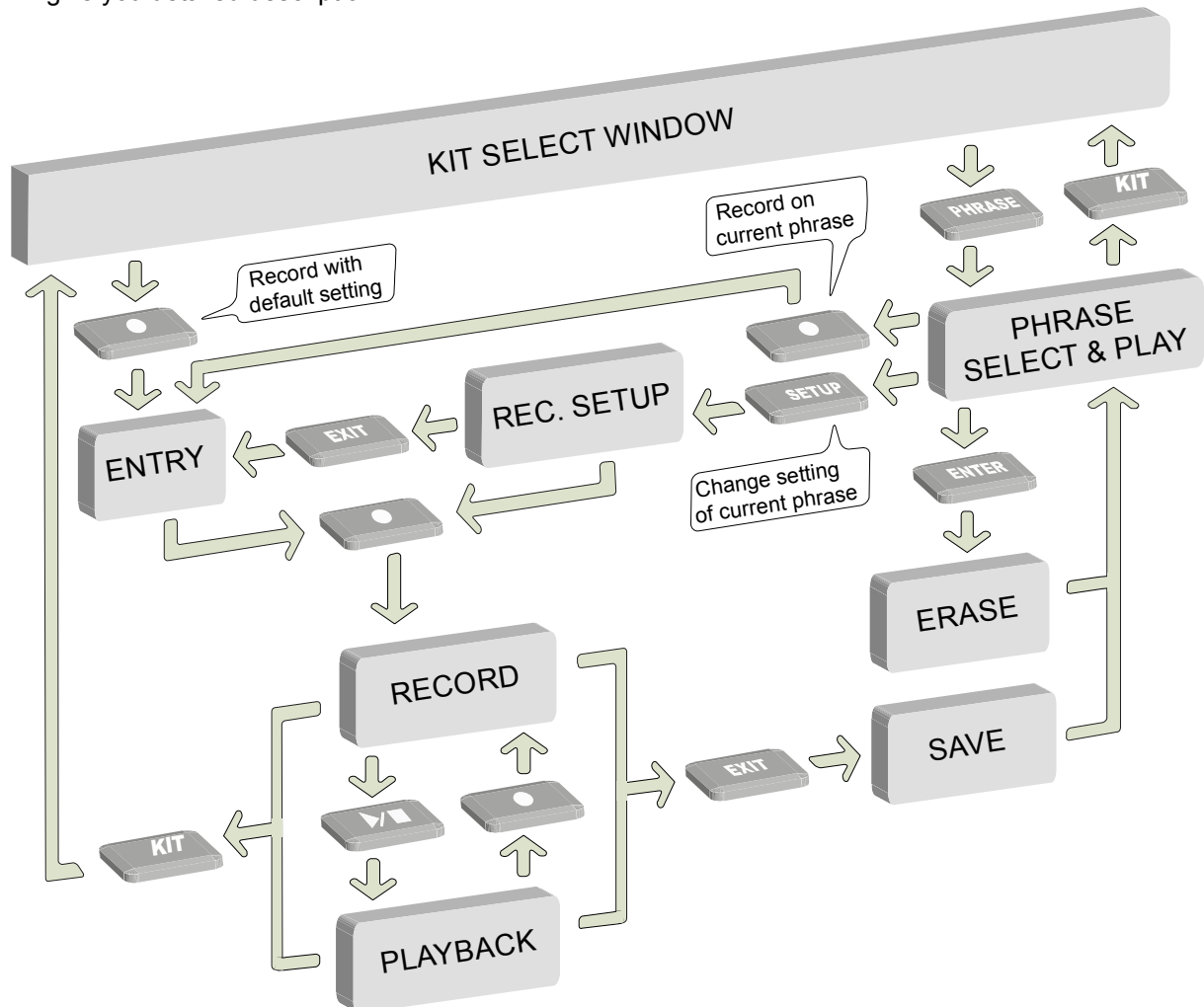

## ENTER THE RECORD MODE

The unit provides 3 ways for your recording. One of them must fit you desire.

### 1. Easy Record

In this way, you don't need to setup anything. All of your current settings will be applied for the recording, including kit selection, effects setting, metronome setting etc. You can record 16-measure phrase in Overdub mode without accompaniment.

In the Kit select window, press the ● button to enter the record entry window. The ● indicator flashes and the PHRASE indicator light up. When "Record" display appears and blinks, press the ENTER button or the ● button to start recording immediately.

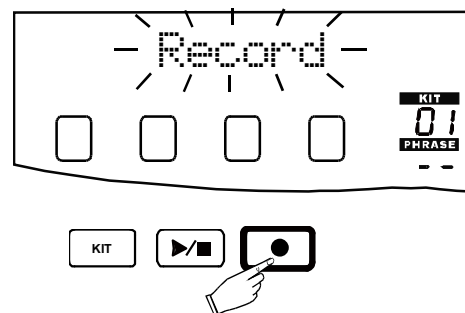

## PHRASE

 **Note:** The phase number in the right side of the screen will be "--".

### 2. Record with Sophisticated Setting

If you want to change some of the default settings, for example, increase the measure, add accompaniment, change the recording mode, even change the kit and effects setting, you need to enter the Record Setup window. In the Kit select window, press the ● button to enter the record entry window. The ● indicator flashes and the PHRASE indicator light up. Then, press the SETUP button to start record setup.

 **Note:** The phase number in the right side of the screen will be "--".

### 3. Recording Based on a Phrase

If you already have phrase recorded, you could edit it or use its frame for new recording. In the kit selection window, press the PHRASE button to enter the phrase select window. Use the Data knob to choose a phrase. The phase number will be displayed in the right side of the screen as well.

You can listen this phrase in advance by pressing the ►/■ button and press the button again to stop it. Then, press the ● button to enter the record entry window for editing.

If you want edit this phrase with setting changes, or create new phrase based on current frame, press the SETUP button to enter the record setup window.

Please refer to the <RECORD SETUP> section of this chapter for more information.

## RECORDER SET UP

You have many optional setup items. When the item name blinks, rotate the Data knob to select then press the ENTER button to confirm and its parameter data will blink. Use the Data knob to change data; then press the ENTER button to confirm your setting and turn to the next item.

 **Tip:** If you don't want to change the current setting of an item, press the ENTER button to skip it and turn to the next item.

Press the ● button to start recording immediately. The settings you have done will go into effect. Press the EXIT button to back to the entry of the Record window.

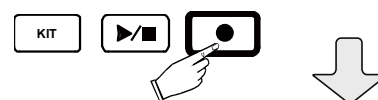
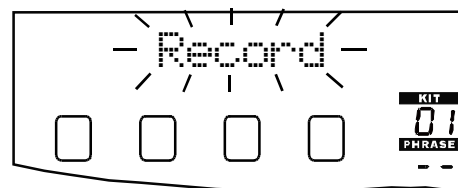

Record setup item

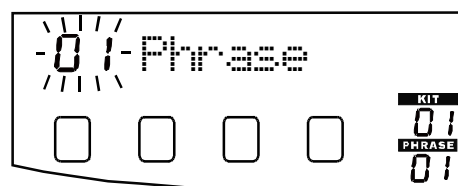
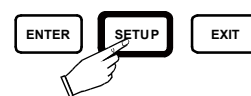
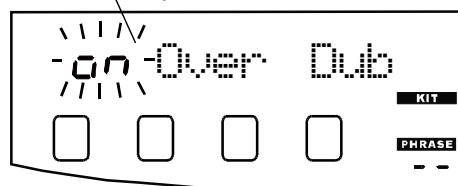

Select phrase

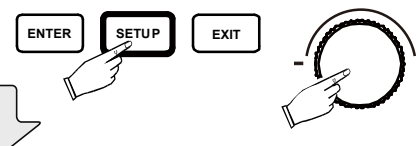
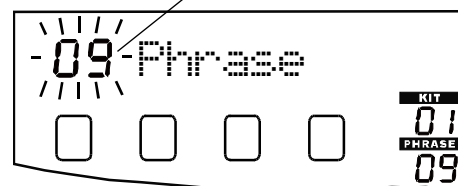

Record setup item    Phrase number

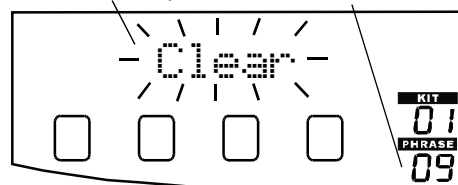

## PHRASE

Items can be set are as follows:

### 1. CLEAR THE PHRASE

- If you enter the setup window from the phrase select & play window, the setup will be based on the phrase selected. There are two options: Clear contents of the phrase and leave its frame to create new phrase, or keep its contents recorded for further edit with the record function. Rotate the Data knob to select On to clear or OFF not to clear, then press the ENTER button to confirm. If you enter the setup window from the kit window directly, this item will skip automatically.

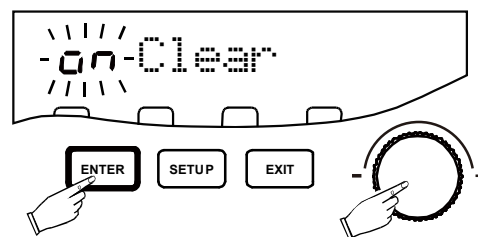

### 2. RECORD MODE

- There are two record mode: Over Dub and Over Write. After finish recording for all measures, it'll restart from the first measure for further recording with contents recorded. The Over Dub mode provides possibility to add more notes and sound tracks to the previous recording. The Over Write mode provides the possibility to replace contents in certain measure with newly playing. The display will show the current mode status, i.e. the Over Dub mode is On or Off. Over Dub oFF represents Over Write mode is On. Rotate the Data knob to change the mode then press the ENTER button to confirm.

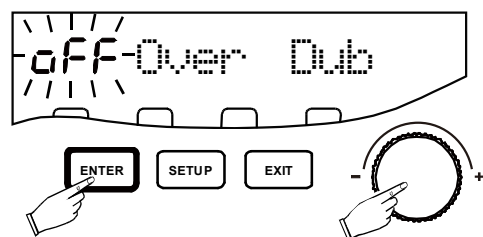

### 3. SELECT A KIT FOR RECORDING

- The current kit selected appears and its number is blinking. Rotate the Data knob to select kit you desire. Press the ENTER button to confirm and turn to the next item.

If the CHAIN mode is engaged, you will select kit in chain.

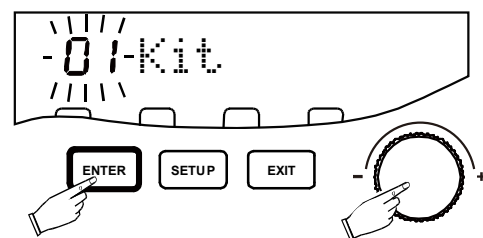

### 4. SELECT ACCOMPANIMENT

4-1 Accompaniment setting - Select accompaniment by the Data knob. The range of the accomp number is 1 - 20 with prefix "A".

Press the ►/■ button to listen it in advance. Press the button again to stop it. After select a accomp then press the ENTER button, it'll turn to the next item to set accomp volume. If you choose oFF, the record will have no orchestra accomp. After press the ENTER button, It'll skip this step and go to the measure setting.

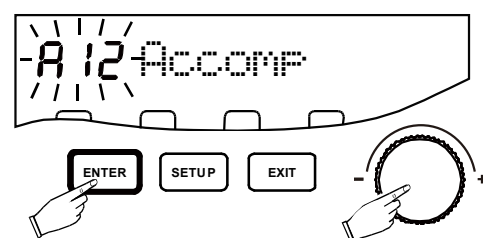

 **Note:** If you enter the setup window from the phrase select & play window and Clear is set to Off, this item will skip automatically.



## PHRASE

4-2 Accompaniment volume - To change the accompaniment volume by rotating the Data knob. The volume range is 0 - 127. If the accompaniment was set to OFF in previous step, this item will be skipped automatically.

 **Note:** If you enter the setup window from the phrase select & play window and Clear is set to Off, this item will skip automatically

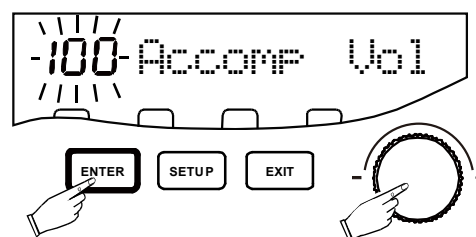

### 5. MEASURE SETTING

- This item for you to set the maximum measure of your record. The current measure setting will appear and blink. Rotate the Data knob to set the measure you desire. The available measure setting is 4, 8, 16, 32 and 999. "999" represents free measure but the Max. measure is 999. Press the ENTER button to confirm and turn to the next item.

 **Note:** If the accompaniment is selected, the measure is fixed by the accompaniment. This item will skip automatically.

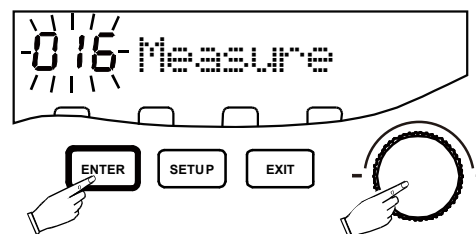

 **Note:** If you enter the setup window from the phrase select & play window, this item will skip automatically.

### 6. BEAT SETTING

- This item for you to set now many beats per measure. If the metronome is engaged, it'll sound per this setting. The current beat appears and blinks. Rotate the Data knob to select beat per measure you desire. The available beat is 2 - 12. Press the ENTER button to confirm and turn to the next item.

 **Note:** If the accompaniment is selected or you enter the setup window from the phrase select & play window, this item will skip automatically.

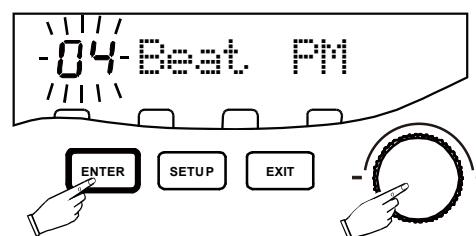

### 7. SET TEMPO

- This item for you to set the tempo. If the metronome is engaged, it'll sound per this setting. The current tempo appears and blinks. Rotate the Data knob to change the tempo. The tempo range is 40 - 240. Press the ENTER button to confirm and turn to the next item.

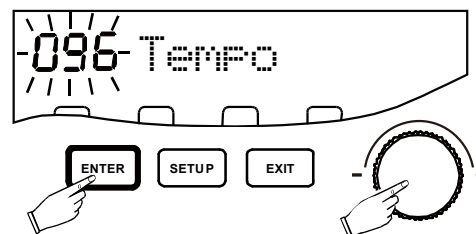

### 8. SET METRONOME VOLUME

- This item for you to set the metronome volume. Rotate the Data knob to change the volume. The volume range is 0 - 127. Press the ENTER button to confirm and turn to the next item.

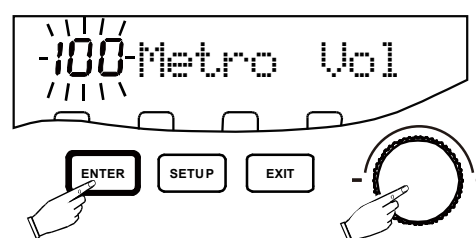

## PHRASE

### 9. REVERB EFFECT

9-1 Reverb Effect Switch - Switch reverb effect On or Off by rotating the Data knob. If it is set to On, after press the ENTER button, it'll turn to following steps to select reverb type and set its level. If you choose Off, it'll jump to the chorus setting directly. Please refer to <SOUND EFFECTS> Chapter for more information about reverb.

9-2 Select Reverb Type - There are 27 reverb types for your choice. The current type code will blink. Rotate the Data knob to select. If the reverb was set to OFF in previous step, this item will be skipped automatically.

9-3 Set Reverb Level - The current reverb level will blink. Rotate the Data knob to set the level ranged 0 - 127. If the reverb was set to OFF in previous step, this item will be skipped automatically.

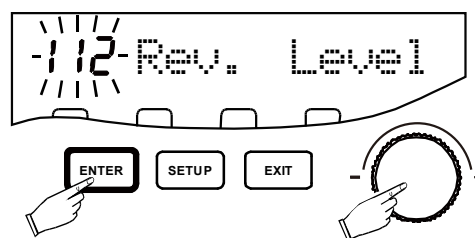
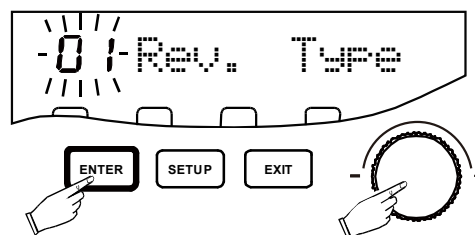
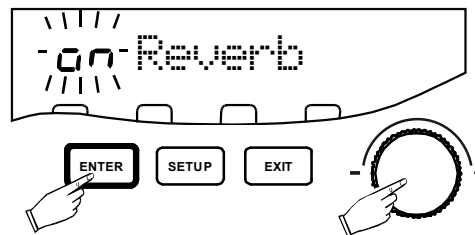

### 10. CHORUS EFFECT

10-1 Chorus Effect Switch - Switch chorus effect On or Off by rotating the Data knob. If it is set to On, after press the ENTER button, it'll turn to following steps to select chorus type and set its level. If you choose Off, it'll jump to the delay effect setting directly. Please refer to <SOUND EFFECTS> Chapter for more information about chorus.

10-2 Select Chorus Type - There are 23 chorus types for your choice. The current type code will blink. Rotate the Data knob to select. If the chorus was set to OFF in previous step, this item will be skipped automatically.

10-3 Set Chorus Level - The current chorus level will blink. Rotate the Data knob to set the level ranged 0 - 127. If the chorus was set to OFF in previous step, this item will be skipped automatically.

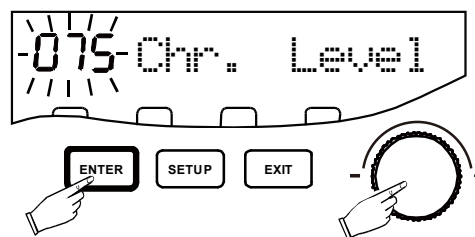
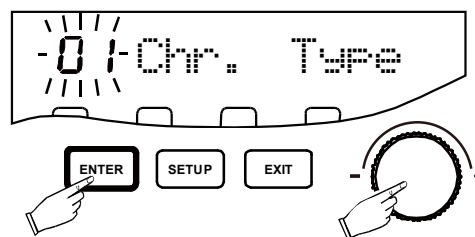
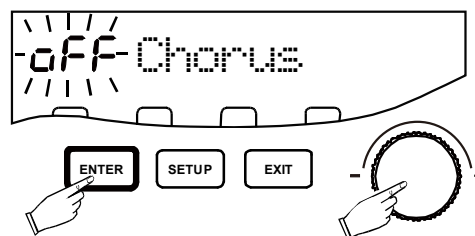

## PHRASE

### 11. DELAY EFFECT

11-1 Delay Effect Switch - Switch delay effect On or Off by rotating the Data knob. If it is set to On, after press the ENTER button, it'll turn to following steps to select delay type and set its level. If you choose Off, it'll jump to the item select window. Please refer to <SOUND EFFECTS> Chapter for more information about delay.

11-2 Select Delay Type - There are 5 delay types for your choice. The current type code will blink. Rotate the Data knob to select. If the delay was set to OFF in previous step, this item will be skipped automatically.

11-3 Set Delay Level - The current delay level will blink. Rotate the Data knob to set the level ranged 0 - 127. If the delay was set to OFF in previous step, this item will be skipped automatically.

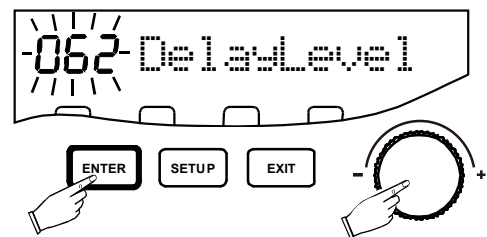
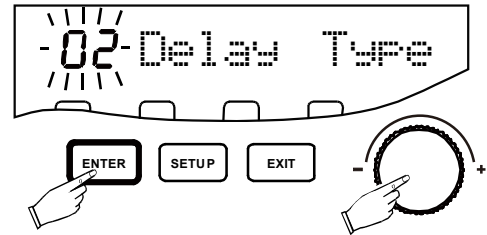
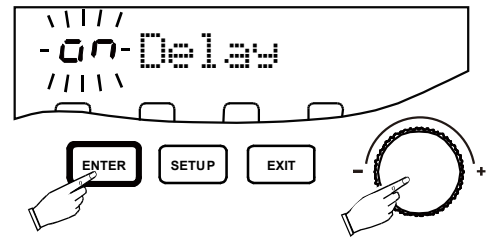

## RECORDING

In any stage of the record setup procedure, press the ● button to start record with the current setting.

The indicator of the ● button will flash and you'll hear one measures count-in metronome sound and "Ready..." will appear on the display. After then, record will start instantly no matter you start play pad or not. The record indicator will stop flash and stays lighting while the CLICK indicator flashes with current beat and tempo accordingly. The display will show preset measure number and recording measure count in real time.

If you have selected an accompaniment style, it'll play as background music for your drum performance.

When the last measure recording is finished, the metronome count-in will start again. Then, it'll return to the first measure for you to continue recording while recorded contents will play back.

When the Over Dub mode is engaged, you can add more sounds to the current recording. Also, you can change kit during the record to add more tracks. This mode provides an easy way to complete your phrase step by step.

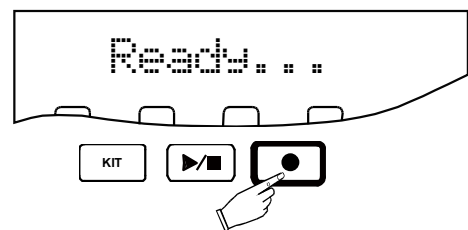

Measure count    Measure number preset

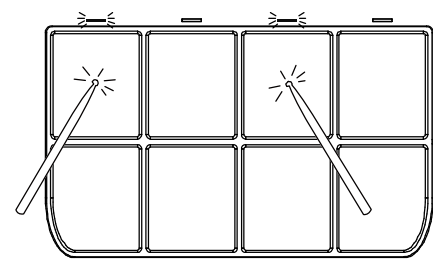
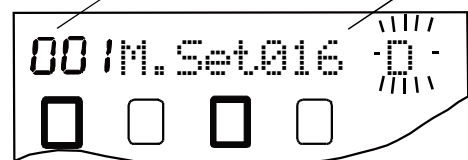

## PHRASE

Another record mode is Over Write. When you play pads, the contents of the current measure will be replaced with your newly performance in this measure. It provides a way to edit your recording in measure base.

The mode mark appears in the most right of the first row. “D” represents as Over Dub and “W” represents as Over Write. You can change the record mode by rotate the Data knob while the mode mark is blinking.

Press the ● button or the ▶/■ button to stop recording instantly, the measure count will stay on. All recorded contents will be in reserve. Press the ● button again to continue record from the first measure.

External instruments playing can be recorded as well.

 **Tip:** If the measure is set to “999”, the maximum recording measure is 999. It wouldn’t repeat automatically unless 999 measures recording are finished. Normally, it seldom occurs because of too many measures. You should press the ● button or the ▶/■ button to stop the record and press the ● button again to continue the recording from the first measure. In this way, you can have free measure record for long phrase.

You can change pad kit during recording. Pressing the KIT button and hold down for 2 seconds, the current kit number in the right column of the display will blink. Use the Data knob to change the kit then press the ENTER button to confirm and exit the setting. The kit number will stop blink.

 **Note:** If the Chain feature is engaged, the kit number will change with the chain.

 **Note:** The sound effects configuration will stay in original setting, though every kit has its own effects configuration.

During the recording, you can change the tempo by pressing and hold the CLICK button for 2 seconds. The current tempo in the right column of the display will blink. Use the Data knob to change it then press the ENTER button to confirm your setting and exit. The tempo will stop blink.

During the record, you can turn the metronome sound On/Off by press the CLICK button.

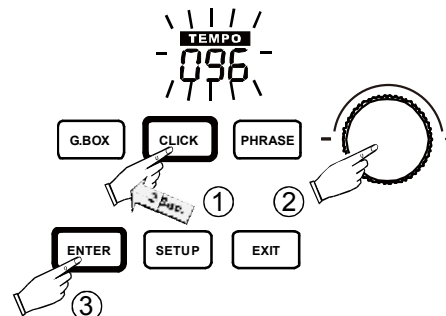
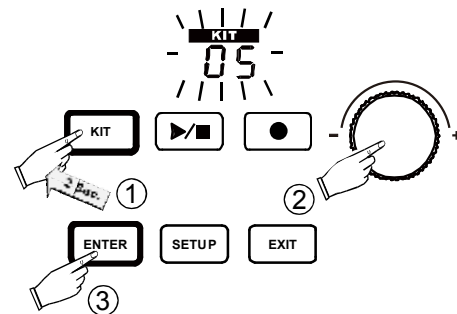
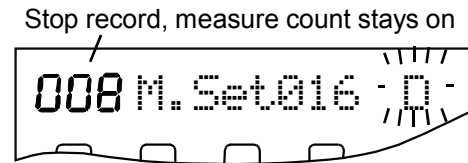
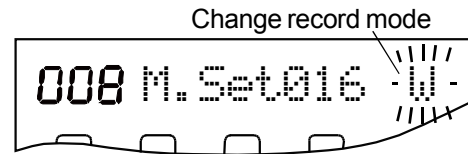

## PHRASE

### PLAYBACK CURRENT RECORDING

When the recording is stopped, press the ▶/■ button and its indicator lights up. After one measure count-in, you'll hear what you recorded from the first measure. The measure count will be displayed as well. The playing repeats in loop until you press the ▶/■ button again to stop it and its indicator will quench.

During the playing back, you can play pads but it'll not be recorded.

You can change the tempo, drum kit and turn On/Off the metronome in the same manner described above.

When the playing is stopped, pressing the ● button to re-enter the record stage to modify your recording. Tempo and drum kit changes you made will stay on.

 **Note:** There is no mode mark in the display and you cannot change the record mode here.

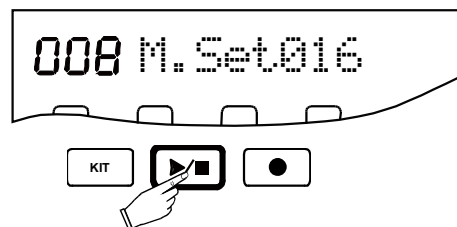

### SAVE RECORDING

You can save your recording as user phrase. The capacity of the drum is to save up to 30 phrases.

When recording or playing back stops, you can enter the save window by pressing the EXIT button. The first available phrase number will appear and blink. Press the ENTER button to save it and turn to the phrase select window. Or, you could change the phrase number to save using the Data knob. If this number is used for previous recording, the display will warn you "Save it?" because this existing phrase will be replaced by new one. Press the ENTER button to save it and turn to the phrase select window.

If you don't want to continue the saving procedure, you have three options:

Press the ● button to go back to the recording stage.

Press the ▶/■ button to go back to the playing stage.

Press the EXIT button to the phrase select window.

 **Note:** If you press the EXIT button, your record will be lost.

 **Tip:** This is the only way to give up current recording operation.

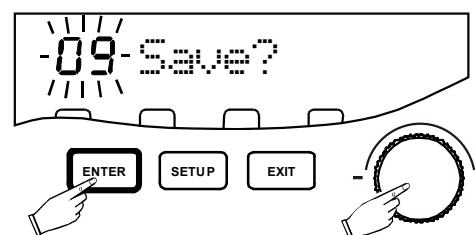
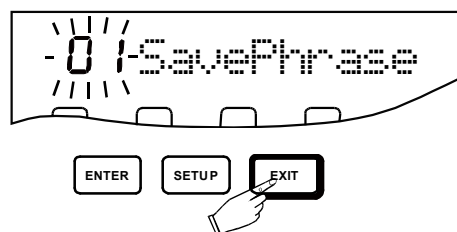

# PHRASE

## PLAY PHRASE

All saved user phrases can be played.

You can enter the phrase select and play mode by pressing the PHRASE button in the kit selection window. You can select phrase within all available numbers. The available number will appear and blink. Rotate the Date knob to select phrase.

If there is no phrase saved, the display will say "No phrase"; after 3 seconds, it'll turn to the record setup window with default settings for you to establish a phrase.

Press the ►/■ button, after one measure count in the phrase playing will start. Press this button again to stop the playing.

There are four play mode which is selected in the Setup function.

- Single Once: Play single phrase once. It'll stop after finish the playing.
  - Single Repeat: Play single phrase repeatedly until press the ►/■ button to stop.
  - All Once: Play all phrases once starting from the current selected phrase. It'll stop after finish all phrases playing.
  - All Repeat: Play all phrases starting from the current selected one repeatedly until press the ►/■ button to stop.
- During the playing, the measure number of this phrase and its real time count will be displayed.

You can change the phrase by the Data knob during the playing. After 2 seconds of the selection, new phrase will start play.

When the playing stops, you can change pad kit. Pressing the KIT button and hold down for 2 seconds, the current kit number in the right column of the display will blink. Use the Data knob to change the kit then press the ENTER button to confirm and exit the setting. The kit number will stop blink.

During the recording, you can change the tempo by pressing and hold the CLICK button for 2 seconds. The current tempo in the right column of the display will blink. Use the Data knob to change it then press the ENTER button to confirm your setting and exit the setting, or, it'll exit automatically after 3 seconds. The tempo will stop blink.

During the record, you can turn the metronome sound On/Off by press the CLICK button.

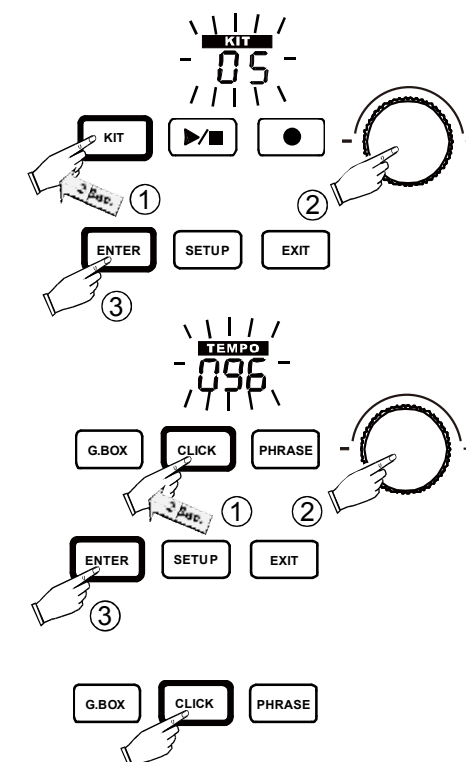
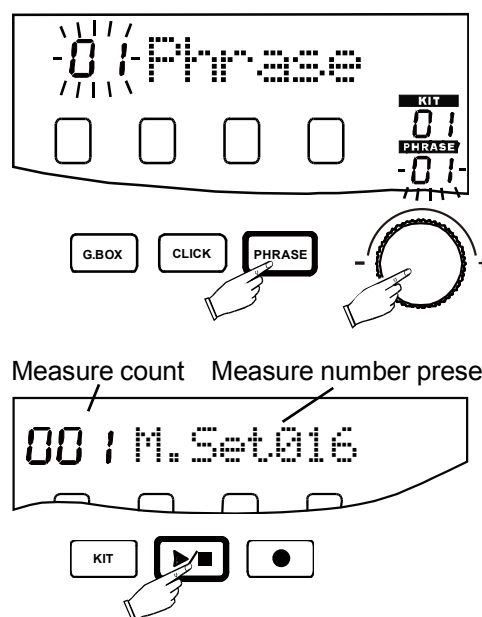

## PHRASE

In the phrase playing stage, you can enter the record operation directly.

Press the ● button to enter the record entry window with the contents and frame of current selected phrase for your edit.

Press the SETUP button to enter the record setup window with the contents and frame of current selected phrase to change record setting then edit your phrase or make new recording.

Press the ENTER button to enter the Erase window.

Press the EXIT button to exit the phrase window and turn to the Kit selection window.

### ERASE PHRASE

In the phrase select window, press the ENTER button to enter the phrase erase window. The current phrase number and "Erase?" will appear on the display.

Press the ENTER button to erase this phrase and go back to the phrase select window.

Press the EXIT button to cancel the erasing operation and go back to the phrase select window.

 **Note:** Be careful! The erased phrase is unrecoverable.

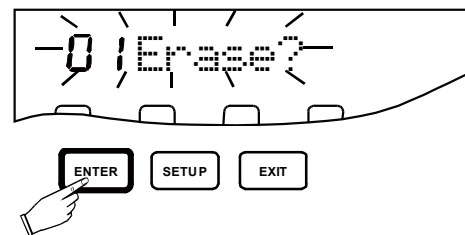

## DRUM KIT EDIT

All 80 preset pad kits and 5 external instrument kits can be edited. You can assign voice to each pad, set its volume and pan etc. Some parameters are for entire kit but not for individual pad such as sound effects type etc, they are also editable.

The diagram below presents major modules and brief control flow of the Drum kit edit function. Following pages will give you detailed description.

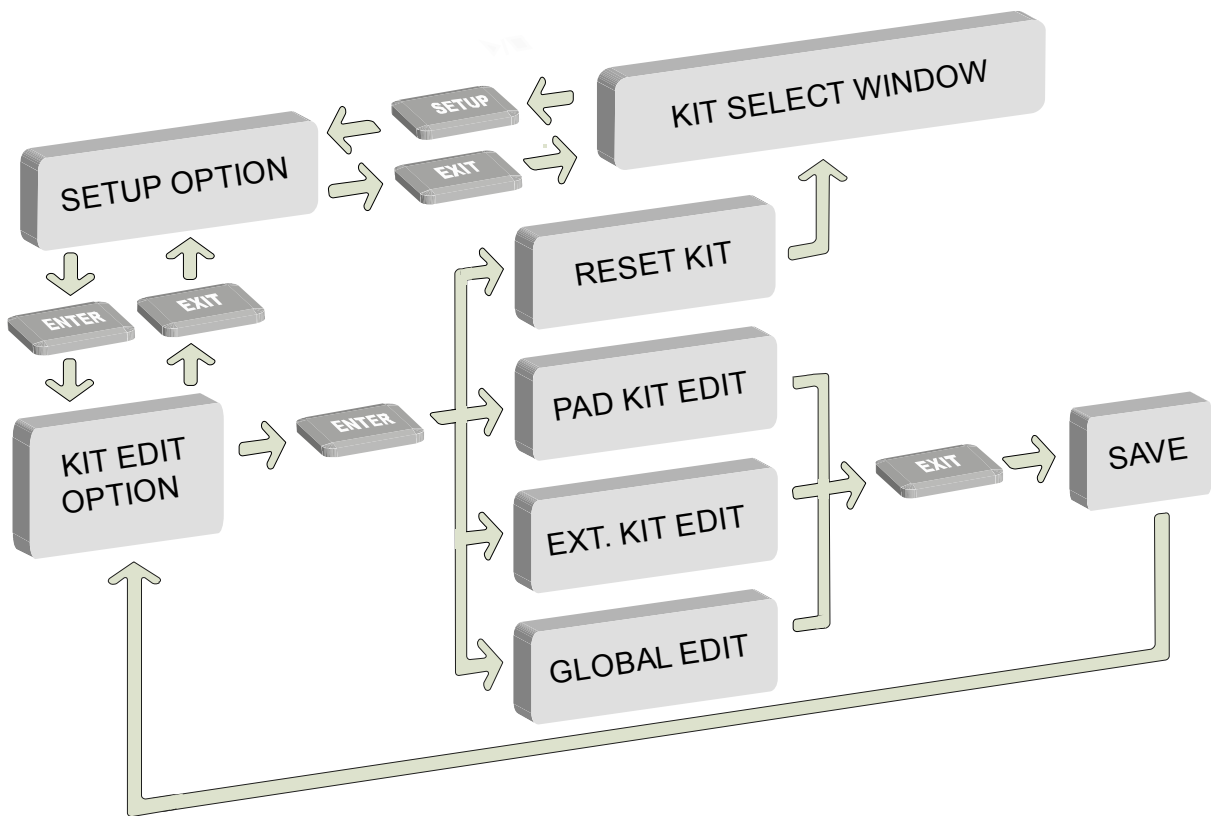

In the Kit select window, press the SETUP button. There are 5 setup items can be selected. Rotate the Data knob until "Kit Edit" appears then press the ENTER button to confirm.

**Note:** Before kit edit operation, you should select a pad kit to be edited.

Press the EXIT button to exit and turn to the Kit selection window.

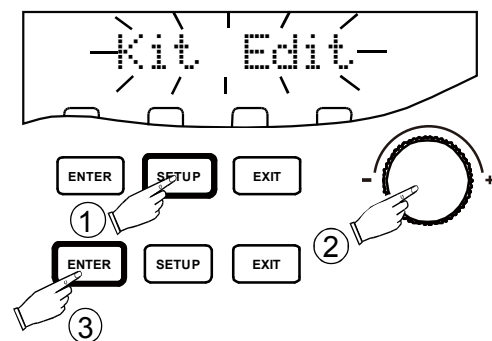



# DRUM KIT EDIT

## PAD KIT EDIT

### 1. PAD KIT EDIT PREPARING

#### (1) Enter the Pad Kit Edit

After entering the Kit Edit, rotate the Data knob until "Pad Kit" appear then press the ENTER button to confirm. Press the EXIT button to exit and back to the Kit Edit window.

#### (2) Select Parameter

There are many parameters can be edited. The first parameter name will appear and blink. Current parameter data will be shown for your reference. Rotate the Data knob to select parameter you want to edit.

#### (3) Select a Pad to Edit

Each pad in the pad kit is editable respectively. After entering the Pad Kit edit window, the default pad to edit is pad 1. You can select another one by striking the pad, its indicator will light up and corresponding block on the display will appear.

 **Note:** When re-enter the Pad kit edit from the Drum kit edit item selection window, the default pad is the last pad you stroke.

 **Tip:** You can edit multiple parameters for a pad by selecting a pad then change the parameter, or you can edit a parameter for multiple pads by selecting a parameter then change the pad.

### 2. EDIT PARAMETERS

After select parameter, press the ENTER button to confirm. Current parameter data will blink. Use the Data knob to change data; then press the ENTER button to confirm your setting and turn to the next parameter.

 **Tip:** If you don't want to change the current setting of an item, press the ENTER button to skip it and turn to the next item.

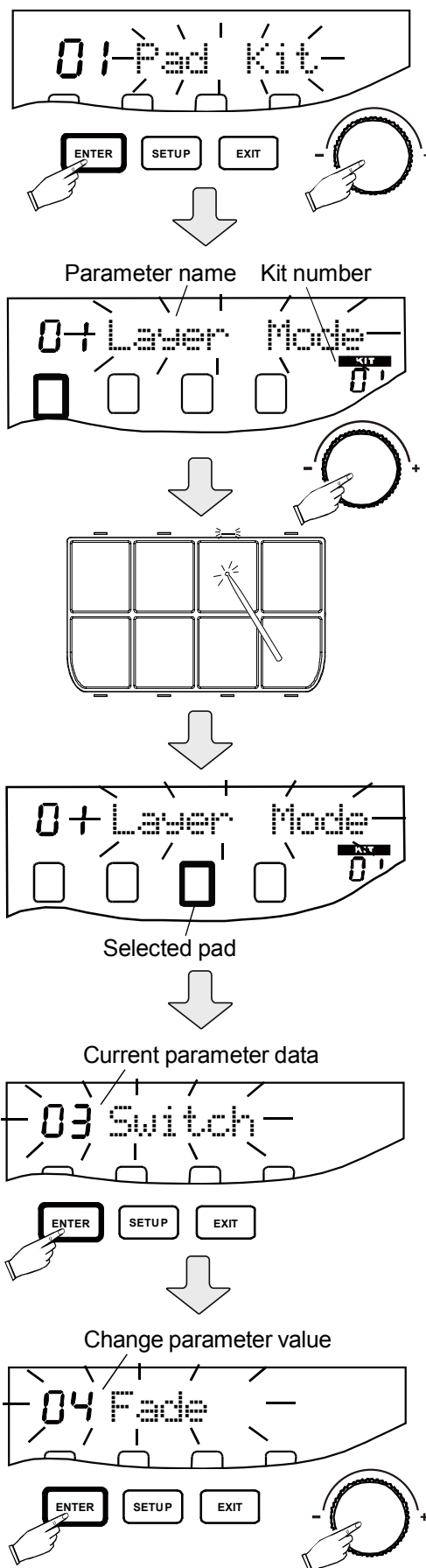

## DRUM KIT EDIT

### (1) LAYER

1-1 Layer Mode - The parameter name is "Layer Mode". Select layer mode from 01 Off, 02 Mix, 03 Switch, 04 Fade and 05 X.Fade. Rotate the Data knob to select then press the ENTER button to confirm. If you choose Off, it'll jump to the voice setting directly; otherwise, continue to edit the next parameter Layer Point.

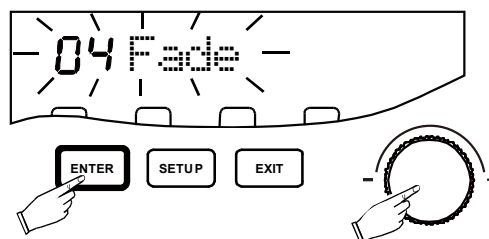

1-2 Layer Point - The parameter name is "LayerPoint". This edit item is available when the layer mode selected is not "Off", otherwise it'll be skipped. The range of the point is 0 - 127. Rotate the Data knob to set the layer Point, then press the ENTER button to confirm. Please refer to the LAYER section of the <DRUM KIT> chapter in this manual for details.

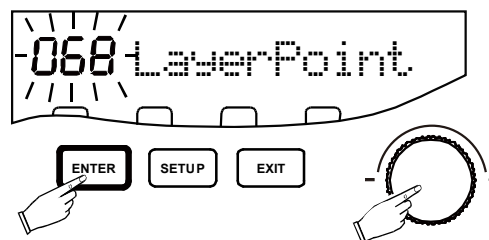

**Each pad could be layered so that it has two voice assignments separately. Also, each layer has multiple parameters such as volume, pan etc should be setup separately. These parameters are marked with "A", "B" to identify which layer it belongs to. If the layer mode is Off, or turn layer off in the Kit Selection window, only parameters with "A" mark go into effect.**

### (2) LAYER A EDIT

#### 2-1 ASSIGN THE VOICE

The parameter name is "Voice A". Assign voice to the pad selected. If the layer mode is not "Off", this assignment is for the layer A. The range of the voice number is 1 - 914. Rotate the Data knob to select voice, then press the ENTER button to confirm. Please refer to <VOICE LIST> in this manual for details.

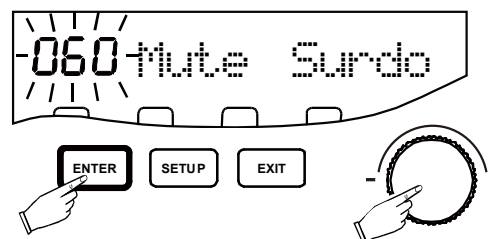

#### 2-2 ADJUST VOLUME

The parameter name is "Volume A". The range of the volume is 0 - 127. Rotate the Data knob to change the volume, then press the ENTER button to confirm.

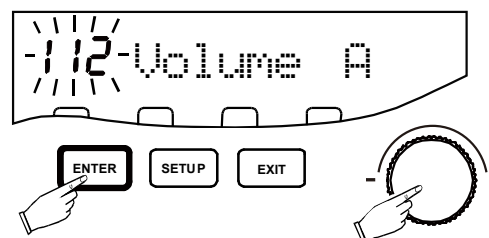

#### 2-3 SET PAN

The parameter name is "Pan A". Sound output from this drum is stereo. This parameter determines the sound position in stereo pan space. The range of the pan is -64 to 63, 0 represents centre position, -64 represents the most left and 63 represents the most right position. Rotate the Data knob to change the volume, then press the ENTER button to confirm.

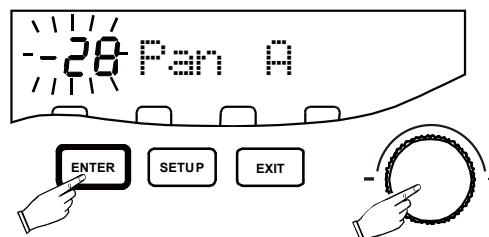

## DRUM KIT EDIT

### 2-4 ADJUST PITCH

The parameter name is "Pitch A". This parameter affects the pitch of the voice. The range of the pitch is -10~10, 0 represents original pitch, -10 is the lowest and 10 is the highest pitch.

Rotate the Data knob to adjust the pitch, then press the ENTER button to confirm.

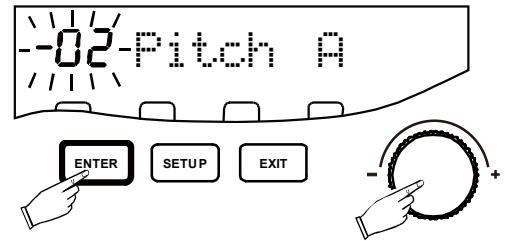

### 2-5 SET REVERB LEVEL FOR PAD

The parameter name is "Reverb A". This parameter determines level of the reverb effect for the pad, i.e. voice. The range of the level is 0 - 127, 127 represents the strongest effect.

Rotate the Data knob to adjust the level, then press the ENTER button to confirm.

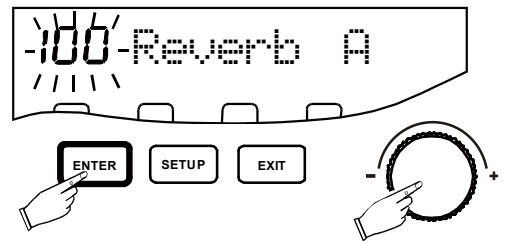

### 2-6 SET CHORUS/DELAY LEVEL FOR PAD

The parameter name is "Chr/Dely A". Chorus and Delay effects share the same level. This parameter determines level of the Chorus and Delay effect for the pad, i.e. voice. The range of the level is 0 - 127, 127 represents the strongest effect.

Rotate the Data knob to adjust the level, then press the ENTER button to confirm.

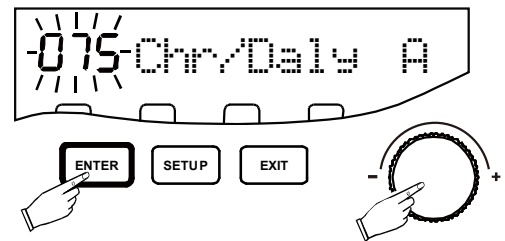

 **Note:** Tremolo and Phaser will not respond to voice level. If the current chorus type is Tremolo or Phaser, this parameter edit will not be effective.

## DRUM KIT EDIT

### (3) EDIT LAYER B

Edit items listed below are available when the layer mode selected is not “Off”, otherwise they’ll be skipped. The way of editing is the same as described above for Voice A.

Parameter	Description	Range
Voice B	Assign voice to the layer B for the pad selected	1 to 914
Volume B	Volume of Voice B	0 to 127
Pan B	Sound position of Voice B in stereo pan space	-64 to 63
Pitch B	Pitch of the voice B	-10 to 10
Reverb B	Level of the reverb effect for the voice B	0 to 127
Chr/Dely B	Level of the Chorus and Delay effects for the voice B	0 to 127
Delay B	Level of the Delay effect for the voice B	0 to 127

 **Note:** Tremolo and Phaser will not respond to voice level. If the current chorus type is Tremolo or Phaser, this parameter edit will not be effective.

### (4) COMPLETE THE PAD KIT EDITING

Press the EXIT button anytime during the editing to terminate.

If you do not make any change, it’ll exit the edit and back to Kit Edit item select window.

If you made change during the edit, you can save edit results. Kit number and “Save?” will appear. Press the ENTER button to save; the current kit configuration will be replaced by your edit results.

Or, press the EXIT button to give up and back to the Kit Edit item select window.

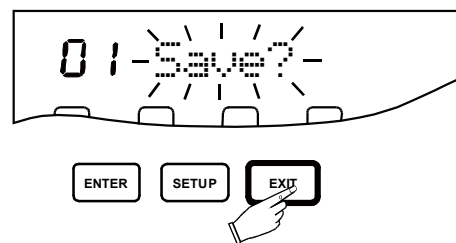

 **Note:** The new setting is nonvolatile even the power turns off. You could recover the default setting with Kit Reset function. Please refer to the Kit Reset section of this chapter for more information.

# DRUM KIT EDIT

## EXTERNAL KIT EDIT

The external kit for expanded instrument is independent from the pad kit. It is also editable.

### 1. EXTERNAL EDIT PREPARING

#### (1) Enter the External Kit Edit

After entering the Kit Edit item selection window, rotate the Data knob until "External" appear with the external kit number with "E" prefix. Then press the ENTER button to confirm. Press the EXIT button to exit and back to the Kit Edit window.

If there is no any external instrument connected, "No Connect" will appear on the display for one second then back to the Kit Edit window.

#### (2) Select Parameter

There are many parameters can be edited. The first parameter name will appear and blink. Current parameter data will be shown for your reference. Rotate the Data knob to select parameter you want to edit.

#### (3) Select an Instrument Part to Edit

Select an instrument by striking it. Please note that some instruments have two or more parts, for example, the snare have head, rim1 and rim2 parts; ride cymbal has head and edge parts etc. Select a part to be edited by striking relevant part, the icon of this instrument on the display will blink.

**Note:** The icon shows selected instrument, but there is no indicator for part.

**Tip:** You can edit multiple parameters for a instrument part by selecting an instrument part then change the parameter, or you can edit a parameter for multiple instrument parts by selecting a parameter then change the instrument part.

All parts can be edited are listed below:

Hi-Hat Pedal	Ride Cymbal Bell
Hi-Hat Open	Snare Head
Hi-Hat Close	Snare Rim 1
Ride Cymbal Bow	Snare Rim 2
Ride Cymbal Edge	Kick Drum

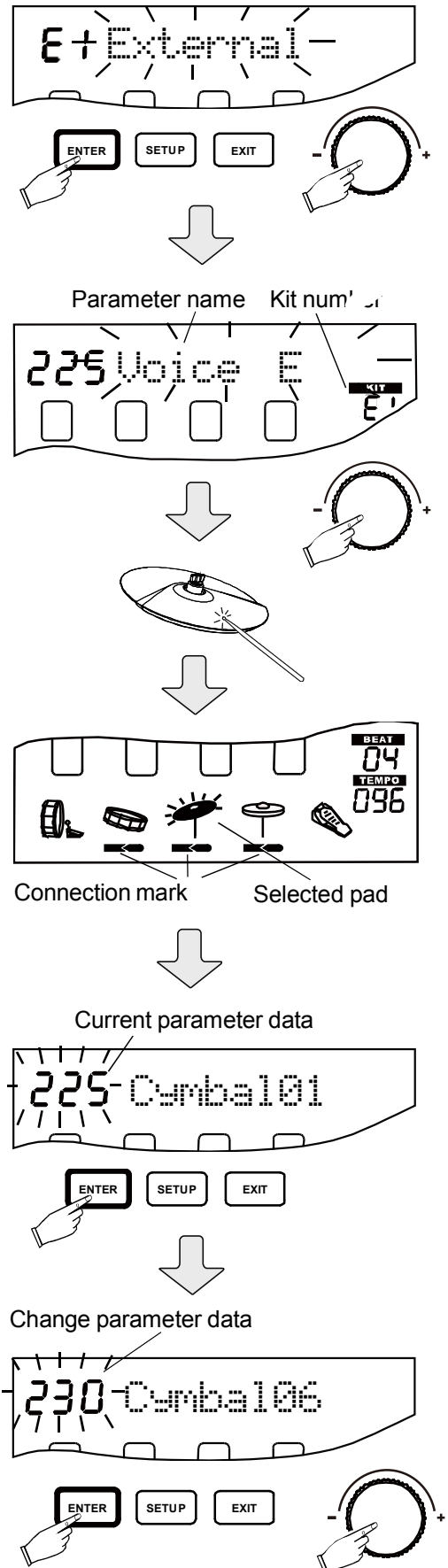



## DRUM KIT EDIT

You may note that there are 3 parts for the Hi-Hat. Strike the Hi-Hat cymbal without pressing the Hi-Hat control pedal to select the Hi-Hat Open; strike the Hi-Hat cymbal while press the Hi-Hat control pedal to bottom to select the Hi-Hat Close; press the Hi-Hat control pedal to bottom but don't strike the Hi-Hat cymbal to select the Hi-Hat Pedal.

### 2. EDIT PARAMETERS

When the parameter is selected and its name blinks, press the ENTER button to confirm and its current data will blink. Use the Data knob to change data; then press the ENTER button to confirm your setting and turn to the next parameter.

 **Tip:** If you don't want to change the current setting of an item, press the ENTER button to skip it and turn to the next parameter.

 **Tip:** During the editing, you can hear results of your setting in real time by striking the part under editing.

The edit items are listed below which are the same as Pad Kit but with suffix E. The way of editing is the same as described above for Layer A.

Parameter	Description	Range
Voice E	Assign voice to the part selected	1 to 914
Volume E	Volume of Voice E	0 to 127
Pan E	Sound position of Voice E in stereo pan space	-64 to 63
Pitch E	Pitch of the voice E	-10 to 10
Reverb E	Level of the reverb effect for the voice E	0 to 127
Chr/Dely E	Level of the Chorus and Delay effects for the voice E	0 to 127

 **Note:** Tremolo and Phaser will not respond to voice level. If the current chorus type is Tremolo or Phaser, this parameter edit will not be effective.

### 3. COMPLETE THE EXTERNAL KIT EDITING

Press the EXIT button anytime during the editing to terminate.

If you do not make any change, it'll exit the edit and back to Kit Edit item select window.

If you made change during the edit, you can save edit results. External Kit number and "Save?" will appear. Press the ENTER button to save; the current kit configuration will be replaced by your edit results.

Or, press the EXIT button to give up and back to the Kit Edit item select window.

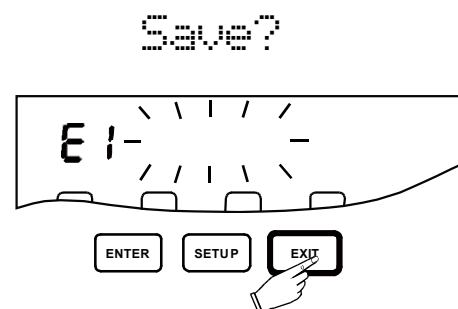
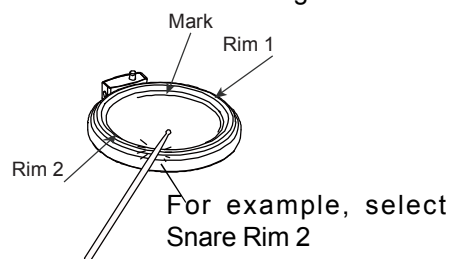
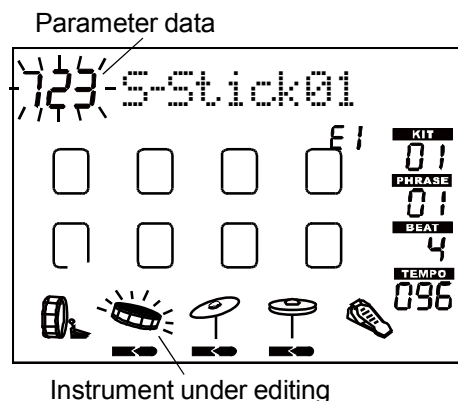

## DRUM KIT EDIT

**Note:** The new setting is nonvolatile even the power turns off. You could recover the default setting with Kit Reset function. Please refer to the Kit Reset section of this chapter for more information.

### GLOBAL EDIT

Some parameters such as sound effects type etc. are for entire kit but not for individual pad or external instrument. You don't need select pad or external instrument in global edit. During the editing, you can hear results of your setting in real time.

#### 1. ENTER THE GLOBAL EDIT

After entering the Kit Edit item selection window, rotate the Data knob until "Global" appears. Then press the ENTER button to confirm.

Press the EXIT button to exit and back to the Kit Edit window.

#### 2. SELECT PARAMETER

There are many parameters can be edited.

The first parameter name will appear and blink. Current parameter data will be shown for your reference. Rotate the Data knob to select parameter you want to edit.

#### 3. EDIT PARAMETERS

When the parameter is selected and its name blinks, press the ENTER button to confirm and its current data will blink. Use the Data knob to change parameter data; then press the ENTER button to confirm your setting and turn to the next parameter.

**Tip:** If you don't want to change the current setting of parameter, press the ENTER button to skip it and turn to the next parameter.

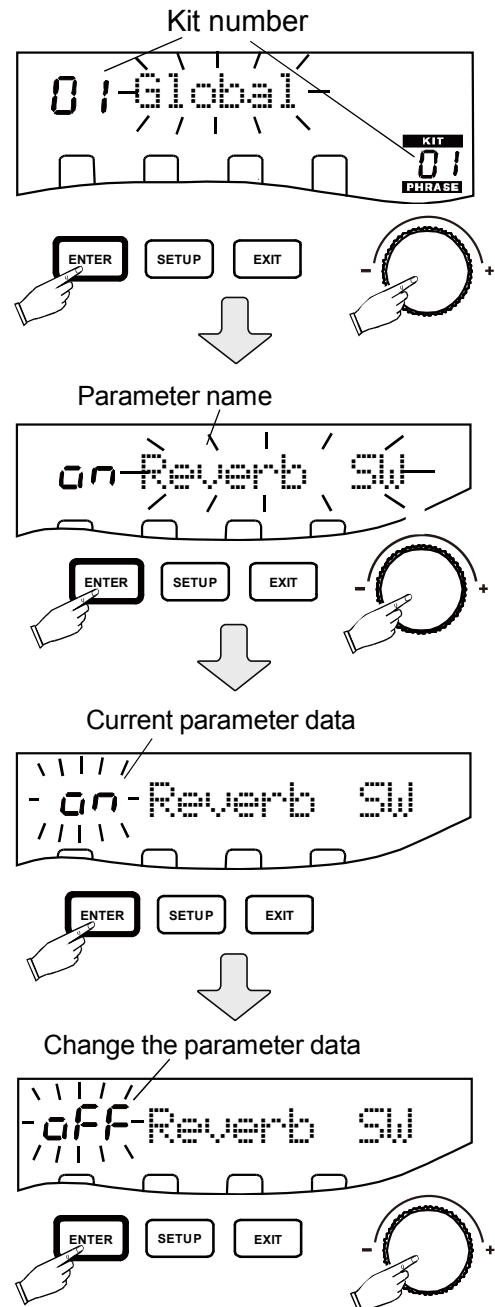

## DRUM KIT EDIT

### (1) REVERB EFFECT EDIT

There are 27 selectable reverb effect types. Please refer to the <SOUND EFFECTS> Chapter and <SOUND EFFECTS LIST> in the back of the Manual for details.

1-1 Reverb Effect Switch - The parameter name is “Reverb SW”. Switch reverb effect On or Off by rotating the Data knob. Rotate the knob clockwise to turn it On and anticlockwise to turn it Off. If it is set to On, after press the ENTER button, it'll turn to following steps to select reverb type and set its level. If you choose Off, it'll jump to the chorus setting directly.

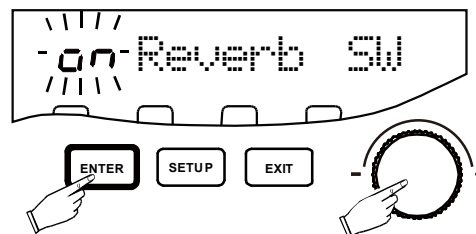

1-2 Select Reverb Type - The parameter name is “Rev. Type”. The current type number and its name will blink. Rotate the Data knob to select. If the reverb was set to Off in previous step, this item will be skipped automatically.

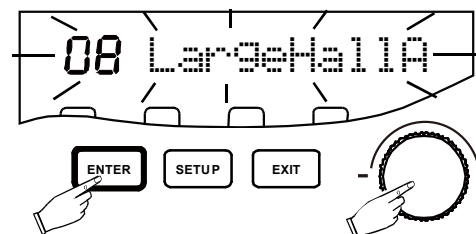

1-3 Set Reverb Level - The parameter name is “Rev. Level”. The current reverb level will blink. Rotate the Data knob to set the level ranged 0 - 127. If the reverb was set to Off in previous step, this item will be skipped automatically.

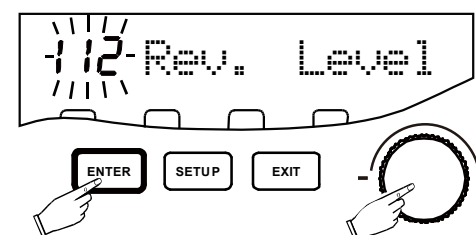

 **Note:** The level is for the selected reverb type. You can adjust reverb voice level for individual pads with the Pad Edit or External Kit Edit functions based on this level.

### (2) CHORUS EFFECT EDIT

There are 23 selectable chorus effect types. Please refer to the <SOUND EFFECTS> Chapter and <SOUND EFFECTS LIST> in the back of the Manual for details.

Parameters of chorus effect edit are:

Chorus SW - Switch chorus effect On or Off

Chr. Type - Select chorus effect type

Chr. Level - Set chorus effect level

 **Note:** Tremolo and Phaser will not respond to the Chr. Level. If the current chorus type is Tremolo or Phaser, this parameter edit will not be effective.

The way of editing is the same as reverb effect edit described above.



## DRUM KIT EDIT

### (3) DELAY EFFECT EDIT

There are 5 selectable delay effect types.

Please refer to the <SOUND EFFECTS> Chapter and <SOUND EFFECTS LIST> in the back of the Manual for details.

Parameters of chorus effect edit are:

Delay SW - Switch chorus effect On or Off

Delay Type - Select chorus effect type

Delay Level - Set chorus effect level

The way of editing is the same as reverb effect edit described above.

 **Note:** If you select Tremolo or Phaser type in the Chorus Effect Edit stage, automatically, items of Delay Effect Edit will not appear.

### 3. COMPLETE THE GLOBAL EDITING

Press the EXIT button anytime during the editing to exit. If you do not make any change, it'll exit the edit and back to Kit Edit item select window.

If you made change during the edit, you can save edit results. Kit number and "Save?" will appear. Press the ENTER button to save; the current kit configuration will be replaced by your edit results.

Or, press the EXIT button to give up and back to the Kit Edit item select window.

 **Note:** The new setting is nonvolatile even the power turns off. You could recover the default setting with Kit Reset function. Please refer to the Kit Reset section of this chapter for more information.

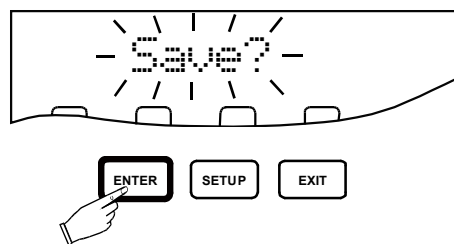

# DRUM KIT EDIT

## KIT RESET

Use this feature you can recover the current pad kit or external kit setting to its default setting.

### 1. ENTER THE KIT RESET

After entering the Kit Edit, rotate the Data knob until “Reset” appear then press the ENTER button to confirm. Press the EXIT button to exit and back to the Setup window.

### 2. RESET THE KIT

(1) Reset the Pad Kit - Rotate the Data knob, when “Reset Pad” is blinking with the pad kit number in front, press the ENTER button. The display will show “Sure?”. Press the ENTER button to confirm and its setting recovers to its default setting, The reset processing needs couple of seconds while the display shows “Reset...”. After reset finished, it'll turn to the Kit window.

Or, press the EXIT button to cancel and it'll back to the Reset item select window.

(2) Reset the External Kit - Rotate the Data knob, when “Reset Ext.” is blinking with the external kit number in front, press the ENTER button. The display will show “Sure?”. Press the ENTER button to confirm and its setting recovers to its default setting, The reset processing needs couple of seconds while the display shows “Reset...”. After reset finished, it'll turn to the Kit window.

Or, press the EXIT button to cancel and it'll back to the Reset item select window.

 **Note:** Don not strike any pad and external instrument after press the ENTER button until it turns to the Kit window. During the reset processing, any button is disabled.

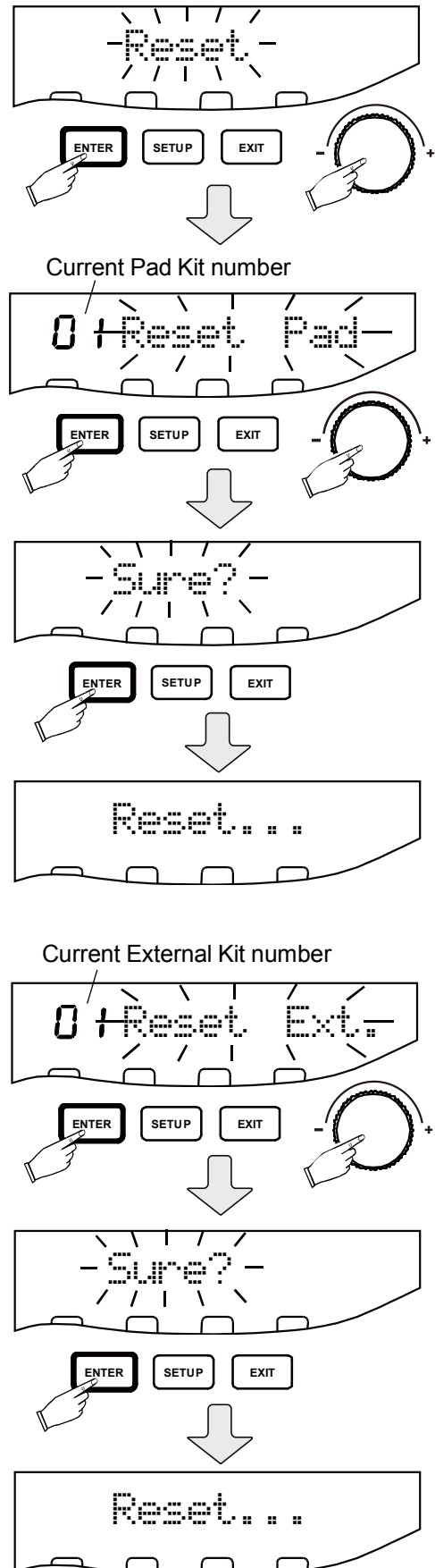

## ADVANCED EDIT

KIT EDIT introduces the sound edit procedure. The purpose of the sound edit is to change sound characteristics such as voice, volume, pan etc. The objects of advanced edit are physical characteristics of respective pad and external instrument such as sensitivity, trigger curve etc. During the editing, you can hear results of your setting in real time by striking the pad under editing.

**Note:** The advanced edit does not link with any specific Pad Kit and External Kit. This is global setting.

The diagram below presents major modules and brief control flow of the Advanced edit function. Following pages will give you detailed description.

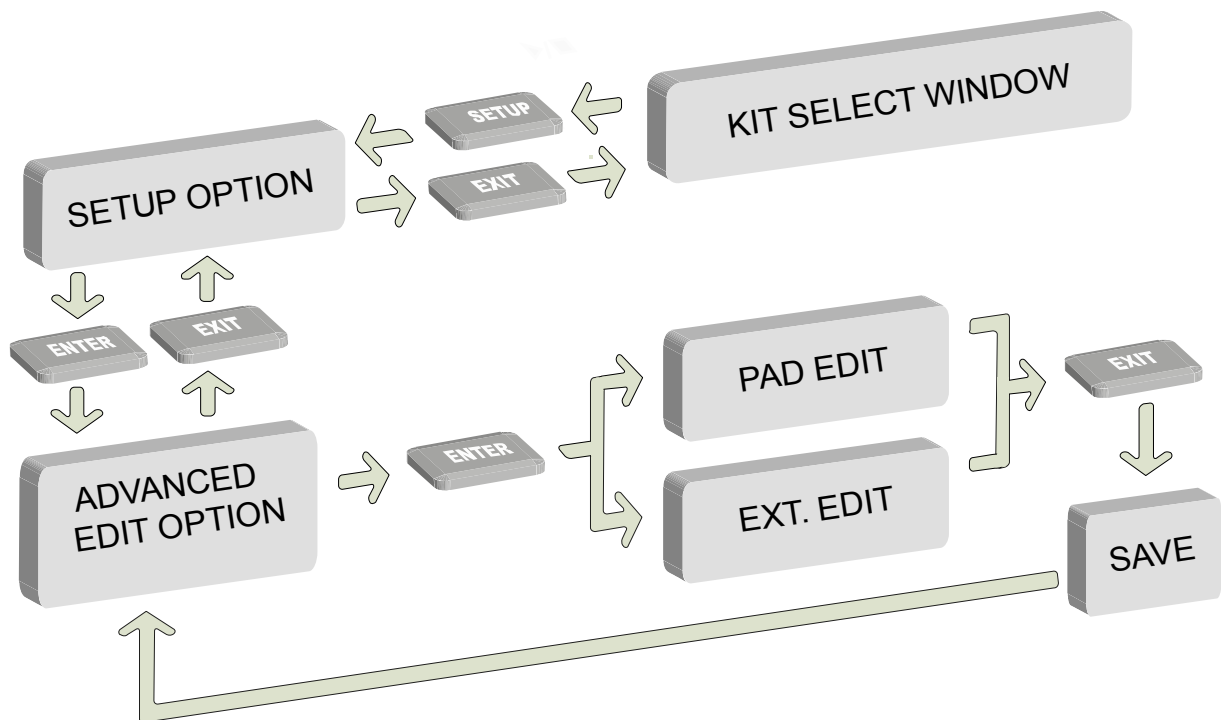

In the Kit select window, press the SETUP button. There are 4 modes can be selected. Rotate the Data knob until "Advanced" appear then press the ENTER button to confirm.

Press the EXIT button to exit and turn to the Kit selection window.

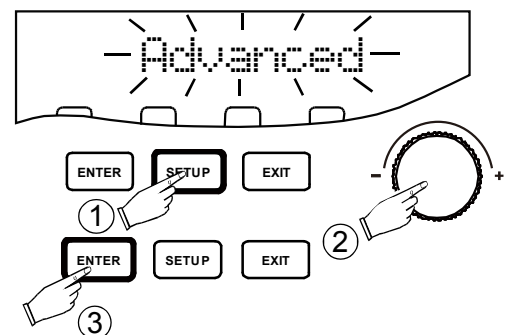

# ADVANCED EDIT

## PAD ADVANCED EDIT

There are two modes of the advanced edit for built-in pad and external instrument separately. The targets of this edit are built-in pads.

### 1. PREPARING

#### (1) Enter the Pad Edit

After entering the Advanced edit, you have two options: "Pad Kit", and "External". Rotate the Data knob until "Pad" appear then press the ENTER button to confirm. Press the EXIT button to exit and back to the Advanced window.

#### (2) Select Parameter

There are many parameters can be edited.

The first parameter name will appear and blink. Its current data will be shown for your reference. Rotate the Data knob to select parameter you want to edit.

#### (3) Select a Pad to Edit

After entering the Pad Kit edit window, the default pad to edit is Pad 1. You can select another one by striking the pad, its indicator will light up and corresponding block on the display will appear.

 **Tip:** You can edit multiple parameters for a pad by selecting a pad then change the parameter, or you can edit a parameter for multiple pads by selecting a parameter then change the pad.

### 2. EDIT PARAMETERS

After select parameter by the Data knob, press the ENTER button to confirm. Its current parameter data will blink. Use the Data knob to change the data of the parameter; then press the ENTER button to confirm your setting and turn to the next parameter.

 **Tip:** If you don't want to change the current setting of an item, press the ENTER button to skip it and turn to the next item.

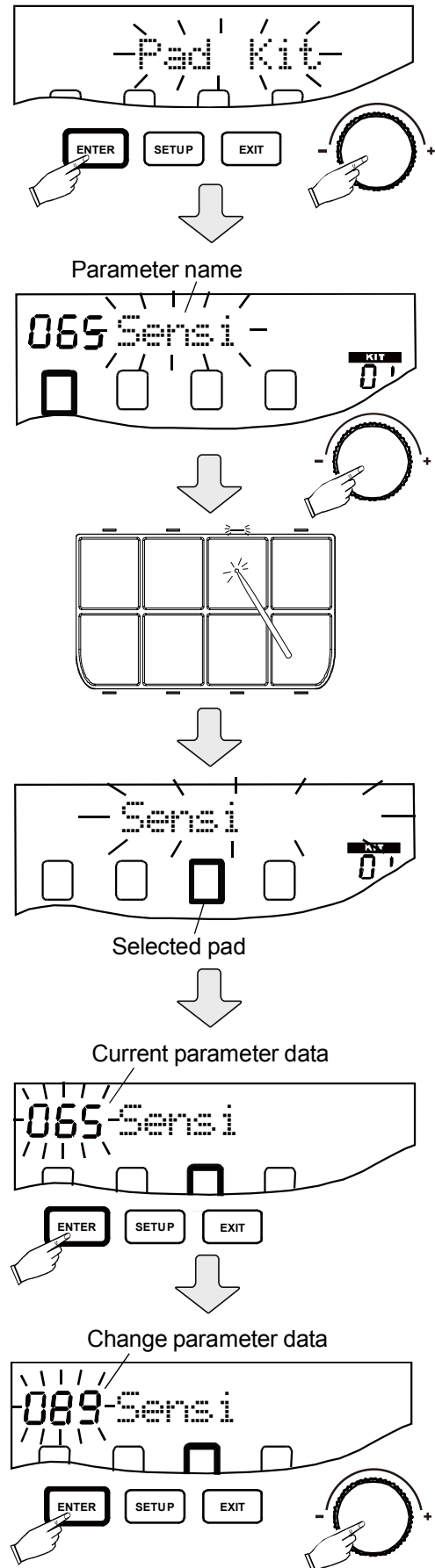

## ADVANCED EDIT

### (1) SENSITIVITY

The parameter name is “Sensi”. The range of pad sensitivity is 0 -127. Rotate the DATA Knob to change it. The higher value represents the higher sensitivity. Please note that if the sensitivity is too high, it’ll cause unexpected sound even if you don’t strike the pad.

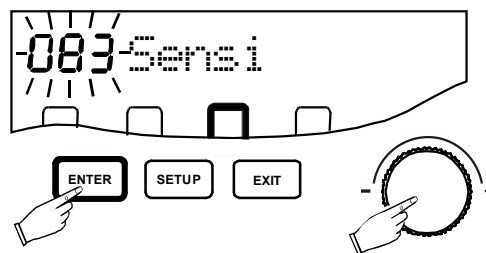

### (2) DYNAMIC RANGE

The parameter name is “Headroom”. This feature allows you to set playing strength, with which you’ll get the maximum volume, to accommodate your personal taste of performance. Strike the pad with strength you desire. The value will appear automatically per your striking. The Max. value is 127.

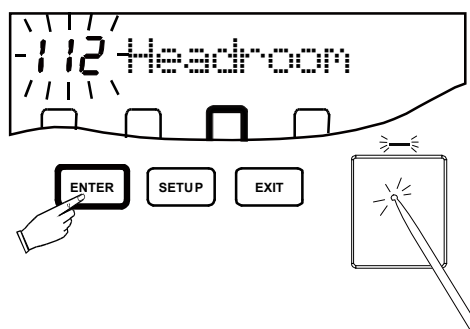

### (3) MASK TIME

The parameter name is “Mask Time”. Occasionally, a single strike could cause double triggering (two sounds instead of one). The Mask Time setting helps to prevent such problems. Once a pad has been hit, any additional trigger signals occurring within the specified Mask Time will be ignored. The higher the value, the easier for sounds to be omitted when strikes the pad fast and repeatedly. The range of the mask time is 0- 127 (msec).

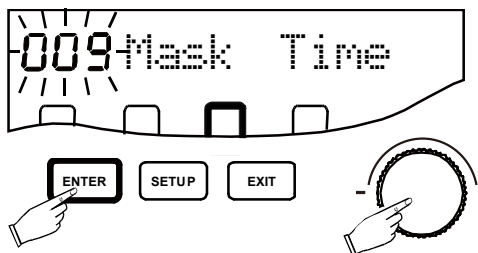

### (4) TRIGGER CURVE

The parameter name is “Trigger”. The trigger curve refers to how trigger signal’s dynamic response relates to your pad striking. You can select a proper curve from 6 preset curves. Rotate the DATA Knob to choose a curve until the response feels as natural as possible. The curves you may select are 1 Linear, 2 Exp and 3 Log. The default curve is Linear.

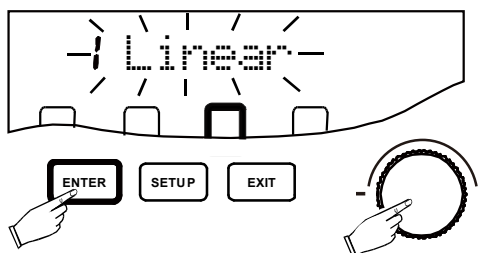
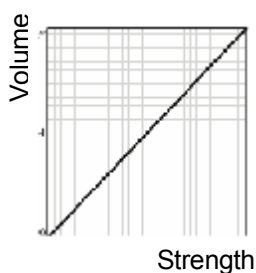
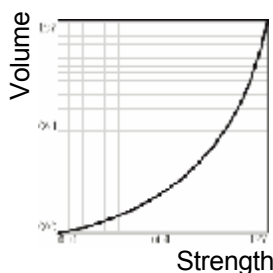

Diagram of 3 types of the curve



Linear



Exp

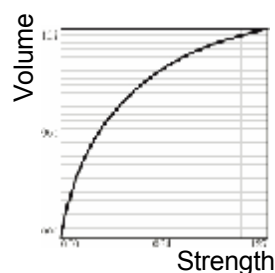

Log

## ADVANCED EDIT

### (5) CROSS TALK

The parameter name is "Cross Talk". When strike a pad, other pad(s) will sound occasionally. It is called cross talk. This feature allows you to eliminate the cross interference among the pads. You should select pad that suffers interference of cross talk.

Rotate the DATA Knob to change the eliminating factor to reduce unexpected cross talking sound. The ranged is 0 - 127. The larger value, the more elimination, but too large value will cause sound missing. You should balance it carefully.

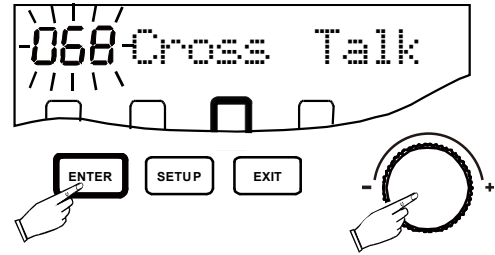

### 4. COMPLETE THE PAD ADVANCED EDIT

Press the EXIT button anytime during the Pad Advanced Edit to exit.

If you do not make any change, it'll exit and back to the Pad/External select window.

If you made change during the Pad Advanced Edit, you can save editing results. The display will show "Save?". Press the ENTER button and the current settings will be saved.

Or, press the EXIT button to give up and back to the Pad/External select window.

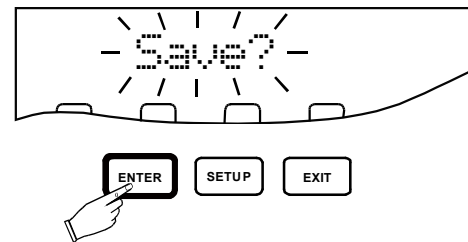

 **Note:** The new setting is nonvolatile even the power turns off. You could recover the default setting with Reset function. Please refer to the <RESET> Chapter for more information.

## ADVANCED EDIT

### EXTERNAL INSTRUMENT ADVANCED EDIT

The targets of this edit are external instruments connected through the Expand Trigger jacks.

#### 1. PREPARING

##### (1) Enter the External Instrument Edit

After entering the Advanced edit, rotate the Data knob until "External" appear then press the ENTER button to confirm. Press the EXIT button to exit and back to the Advanced window.

If there is no any external instrument connected, "No Connect" will appear on the display for one second then back to the Advanced edit item select window.

##### (2) Select Parameter

There are many parameters can be edited.

The first parameter name will appear and blink. Rotate the Data knob to select parameter. The current parameter data will be shown for your reference.

Parameters of external instruments are the same as built-in pad, except Hi-Hat Control pedal. Please refer to (5) Hi-Hat Control Pedal Edit in the next page for details.

##### (3) Select an Instrument to Edit

After entering the External edit window, the default instrument to edit is Snare. You can select another one by striking it, no matter what part you hit. Its icon on the display will blink.

 **Note:** Press the Hi-Hat control pedal to the bottom to select it. Its edit procedure is different. Please refer to HI-HAT CONTROL PEDAL section in the next page for details.

 **Tip:** You can edit multiple parameters for a instrument by selecting an instrument then change the parameter, or you can edit a parameter for multiple instruments by selecting a parameter then change the instrument.

#### 2. EDIT PARAMETERS

After select parameter, press the ENTER button to confirm. Its current parameter data will blink. Use the Data knob to change the data of the parameter; then press the ENTER button to confirm your setting and turn to the next parameter.

 **Tip:** If you don't want to change the current setting of an item, press the ENTER button to skip it and turn to the next item.

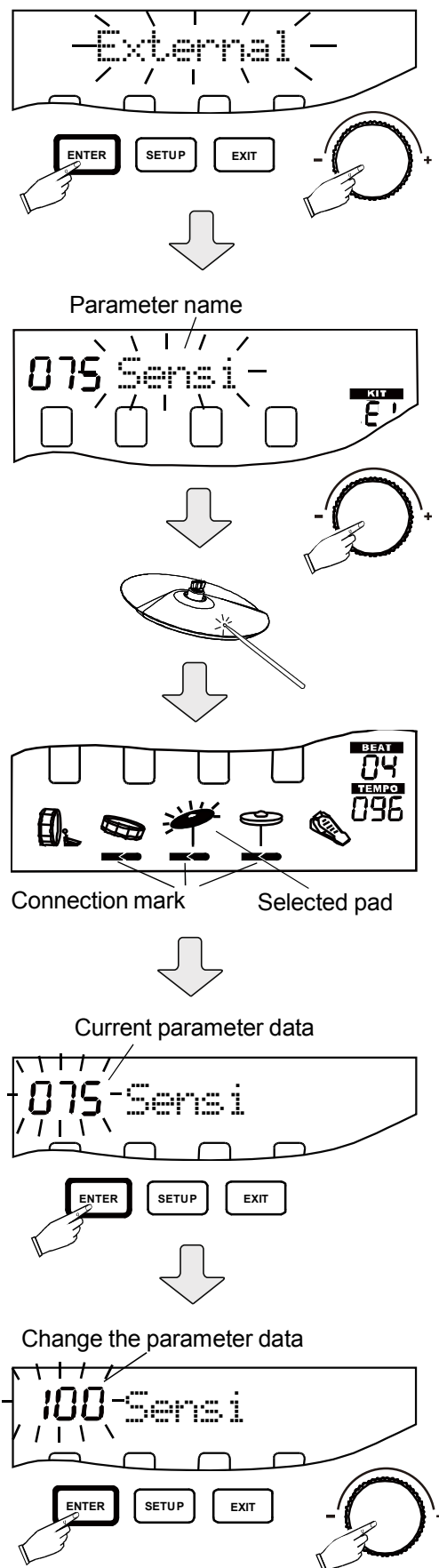

## ADVANCED EDIT

### 3. HI-HAT CONTROL PEDAL

There are 3 categories of Hi-Hat sound: Open Hi-Hat sound, Close Hi-Hat sound and Hi-Hat peal sound.

When press the pedal quickly and reach the specific point, it makes Hi-Hat pedal sound and don't need to strike the Hi-Hat pad. The pressing pedal is quicker, the volume is higher.

Strike the Hi-Hat without pressing the Hi-Hat control pedal; it makes open Hi-Hat sound.

Strike the Hi-Hat pad while press the Hi-Hat control pedal over a specific point, the sound by striking will change from open Hi-Hat sound to close Hi-Hat sound gradually, meanwhile the Hi-Hat pedal sound is also generated. This specific point is called Pedal Threshold.

The Hi-Hat pedal setting is different from other instruments.

When you select Mask Time in the parameter select step, press the Hi-Hat control pedal to its bottom position to select this external device.

There are 4 parameters for Hi-Hat control pedal advanced edit.

**Sensitivity** - The parameter name is "Sensitivity". It determines how sensitive to make Hi-Hat pedal sound by pressing the pedal. The range of it is 0 - 127. Rotate the Data Knob to set the value, then press the ENTER button to confirm.

**Dynamic Range** - The parameter name is "Headroom". It determines how quick pressing the pedal to get maximum volume of the Hi-Hat pedal sound. The range of it is 0 - 127. Rotate the Data Knob to set the value, or press the pedal with your desired strength then press the ENTER button to confirm.

**Pedal Threshold** - The parameter name is "Pedal THR". It determines the position of the Pedal Threshold point. The scale of Hi-Hat pedal movement is 0 - 127. The top position of the pedal is defines as 127 and bottom is 0. Rotate the Data Knob to set the value, or press the pedal to your desired position then press the ENTER button to confirm.

**Trigger Curve** - The parameter name is "Trigger". Select a proper curve for making Hi-Hat pedal sound. Please refer to the Pad Advanced Edit section for details. Rotate the Data Knob to select, then press the ENTER button to confirm.

 **Note:** Actually, there is no Mask Time and Cross Talk parameters to edit, even you enter the Hi-Hat control pedal edit mode by selecting the Mask Time parameter.

### 4. COMPLETE THE EXTERNAL INSTRUMENT ADVANCED EDIT

Press the EXIT button anytime during the Pad Advanced Edit to exit.

If you do not make any change, it'll exit and back to the Pad/External select window.

If you made change during the Pad Advanced Edit, you can save editing results. "Save?" will appear. Press the ENTER button and the current settings will be saved.

Or, press the EXIT button to give up and back to the Pad/External select window.

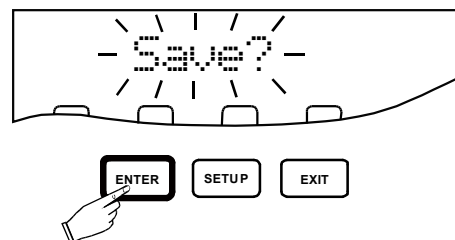

 **Note:** The new setting is nonvolatile even the power turns off. You could recover the default setting with Reset function. Please refer to the <RESET> Chapter for more information.



## SYSTEM SETUP

This function provides utilities to setup system parameters such as Chain assignment, Pedal setting, Master tune etc. This function also provides user effects feature that allows you to create your own effects. All of these settings are applied to entire unit instead of particular drum kit and pad/instrument.

The diagram below presents major modules and brief control flow of the Drum kit edit function. Following pages will give you detailed description.

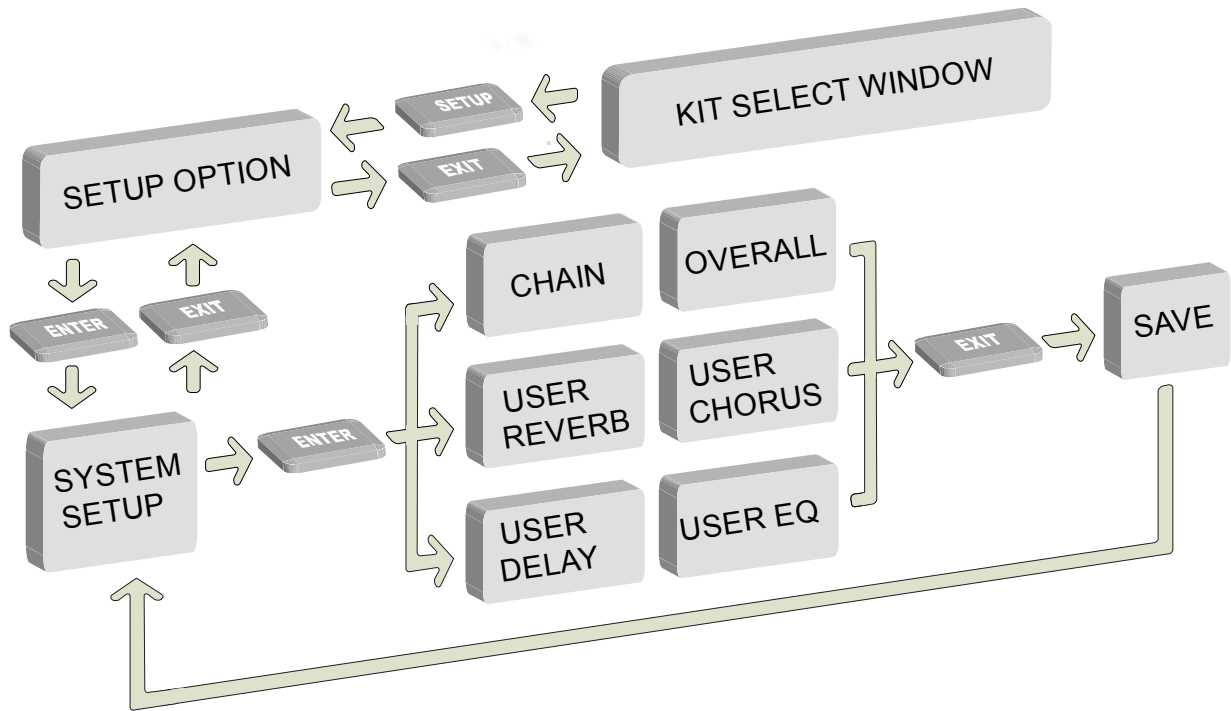

In the Kit select window, press the SETUP button. There are 4 items can be selected. Rotate the Data knob until "System" appear then press the ENTER button to confirm.

Press the EXIT button to exit and turn to the Kit selection window.

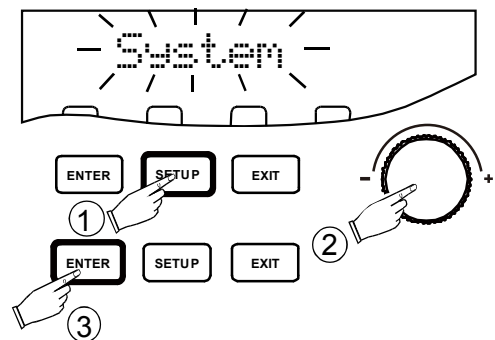

# SYSTEM SETUP

## GENERAL SETUP PROCEDURE

The System Setup function consists of six sub-function modules. Their edit procedure is basically the same.

### 1. SELECT SUB-FUNCTION

After entering the System Setup, you have six optional sub-functions: "Chain", "Overall", "User Reverb", "User Chorus", "User Delay" and "User EQ". Rotate the Data knob until the item you desire appears then press the ENTER button to confirm.

Press the EXIT button to exit and back to the System setup option window.

### 2. SELECT PARAMETER

There are many parameters can be edited.

The first parameter name will appear and blink. Current parameter data will be show for your reference. Rotate the Data knob to select parameter you want to edit.

### 3. EDIT PARAMETERS

After select parameter, press the ENTER button to confirm. Current parameter data will blink. Use the Data knob to change data of the parameter; then press the ENTER button to confirm your setting and turn to the next parameter.

 **Tip:** If you don't want to change the current setting of an item, press the ENTER button to skip it and turn to the next item.

 **Note:** The diagram in the right shows an example of the Chain setup procedure.

### 4. COMPLETE AND EXIT THE SETUP

Press the EXIT button anytime during the setup to terminate.

If you do not make any change, it'll exit and back to System setup item select window.

If you made change during the setup, you can save setting results. "Save?" will appear. Press the ENTER button and the current settings will be saved. Or, press the EXIT button to give up and back to the System setup Item select window.

 **Note:** The new setting is nonvolatile even the power turns off. You could recover the default setting with Reset function. Please refer to the <RESET> chapter for more information.

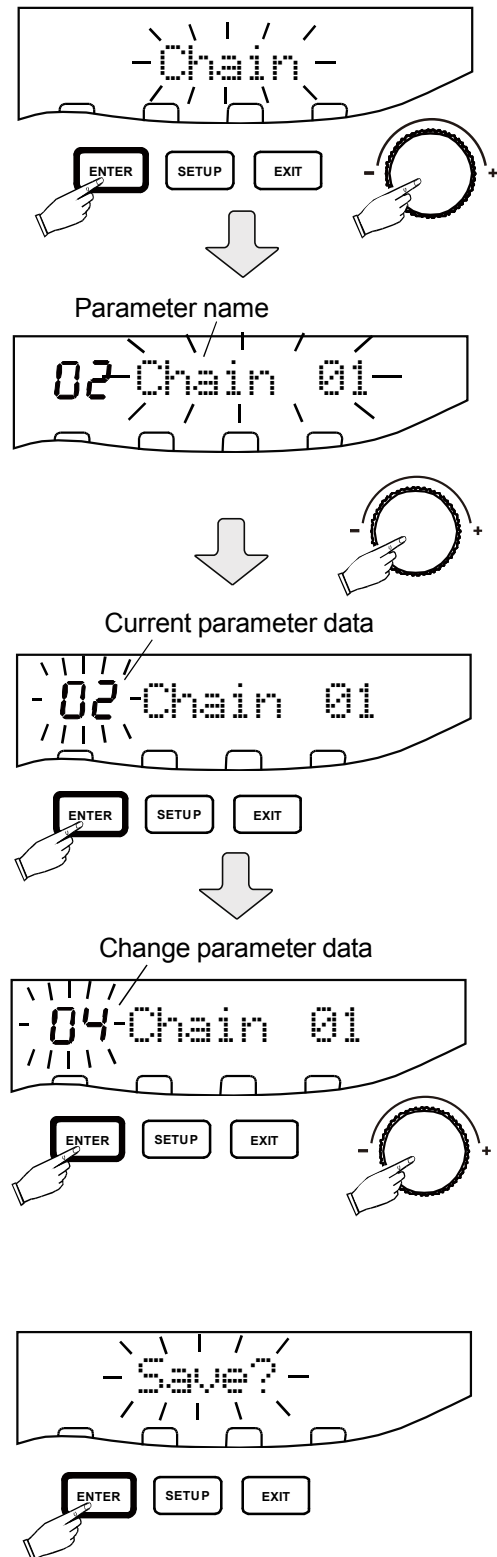

## SYSTEM SETUP

### CHAIN

You can assign your favorite Kit to Chain. Parameters are Chain01 to Chain10. Rotate the Data knob to select kit number to assign to the current chain number. Press the ENTER button to confirm and turn to the next chain number.

Press the EXIT button to exit.

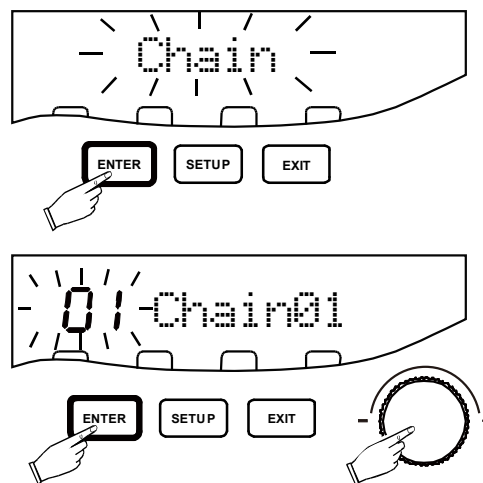

### OVERALL SETTINGS

#### 1 EQUALIZER

The parameter name is "Equalizer".

Tone of the drum could be adjusted globally by built-in Equalizer. There are 8 types of preset equalizer listed below. The default setting is 01 Normal 1.

All selectable equalizer types are listed in next page.

No.	EQUALIZER TYPE
01	Normal 1
02	Normal 2
03	Bass Boost
04	Bass Mid
05	Moderate
06	Bright Mid
07	Bright
08	Bright High
09	User EQ

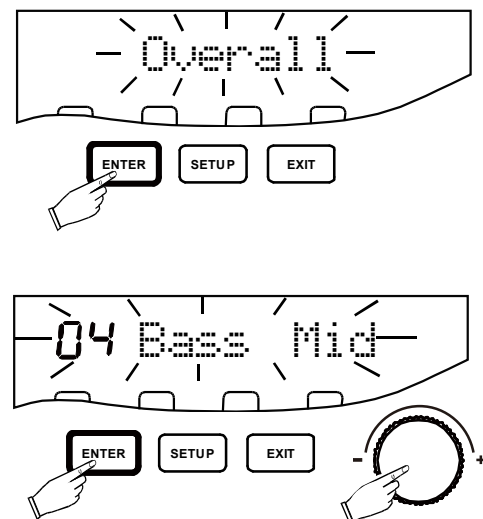

#### 2 MASTER VOLUME

The parameter name is "Master Vol".

This parameter determines the master volume. The master volume range is 0 to 127.

 **Note:** The MASTER VOLUME knob can adjust the master volume as well. But, that adjustment is temporary. The master volume setting here can be saved. When the power turns on, the master volume is set to your saved setting, and then use the MASTER VOLUME Knob to adjust accordingly.

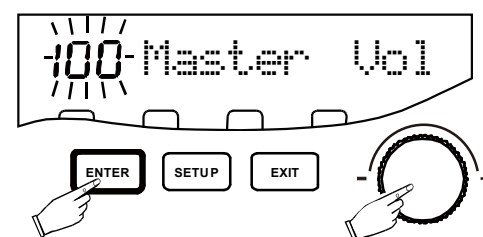

## SYSTEM SETUP

### 3 MASTER TUNE

The parameter name is "Master Tune".

This parameter affects sound pitch globally. The range of the master tune is 0 to +/- 50. The default Setting is 0 which refers to 440 Hz at A1 note.

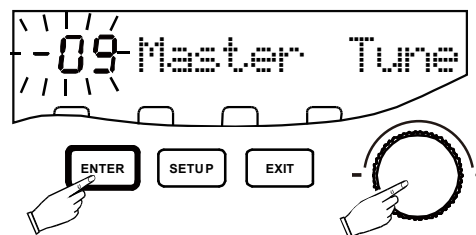

### 4 PEDAL SWITCH FUNCTION

The parameter name is "P.SW Func.".

The pedal can be assigned to data plus/minus, Start/Stop function for easy operation with the pedal.

Rotate the Data Knob to select "Plus", "Minus" or "Start/Stop". The default setting is "Plus".

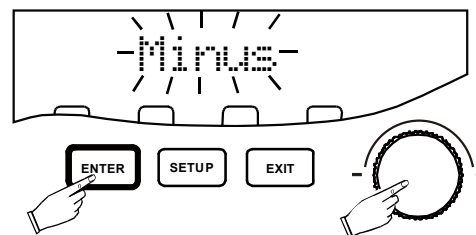

### 5 PEDAL EFFECTIVE ACTION

The parameter name is "P.SW Action". The switch can be effective by pressing or releasing the pedal. Rotate the DATE knob to select "Press" or "Release". The default setting is "Press". Press the ENTER button to confirm and turn to the next parameter.

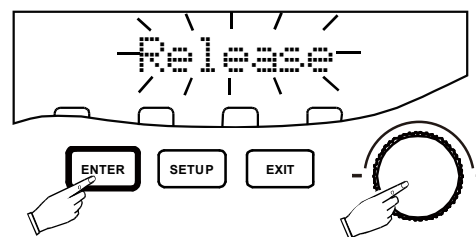

### 6 LOCAL

The parameter name is "Local".

When Local is On, sound is generated by inner sound engine and you can hear sound by headphone or external speaker. When it is Off, the inner sound engine does not engage and you cannot hear sound, but the drum transmits MIDI message of your playing. Rotate the knob clockwise to turn it On and anticlockwise to turn it Off. The default setting is On.

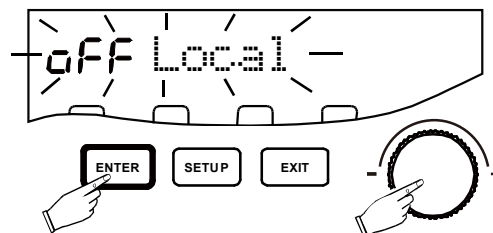

### 7 PHRASE PLAYING MODE

The parameter name is "PhrasePlay".

You have 4 options which determines phrase play mode:  
1 SingleOnce: Play single phrase once. It'll stop after finish the playing.

2 SingleRept: Play single phrase repeatedly until press the ►/■ button to stop.

3 All Once: Play all phrases once. It'll stop after finish all phrases playing.

4 All Repeat: Play all phrases repeatedly until press the ►/■ button to stop.

Rotate the Data Knob to select. The default setting is SingleOnce.

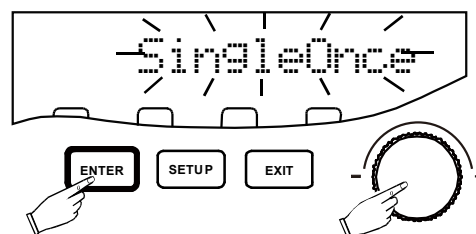

## SYSTEM SETUP

### USER REVERB EFFECT

This function makes it possible to create your own reverb effect. It'll be included in the Sound Effects List named UserReverb for your choice. There are 4 parameters for User Reverb setup.

#### 1. PRE-DELAY TIME

The parameter name is "Pre-Delay". It represents the time from the first reflection to the reverb. Rotate the Data Knob to change the pre-delay value. The range is 0 - 127, 127 represents 250ms.

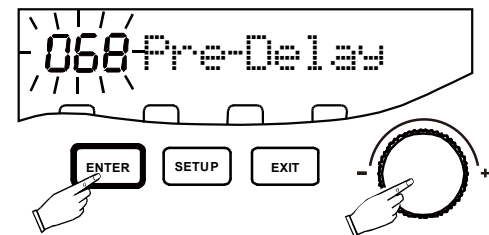
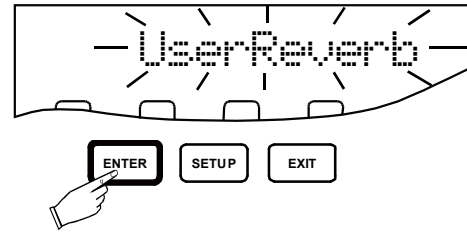

#### 2. REVERB TIME

The parameter name is "ReverbTime". It defines the time it takes for the reflected sound from the room to decay or die away. Rotate the Data Knob to change the value. The range is 0 - 127, 127 represents 250ms.

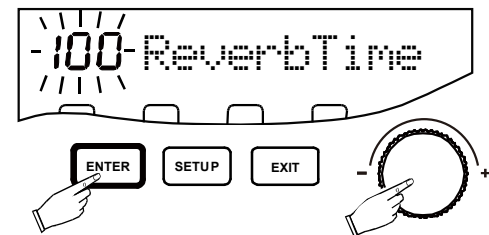

#### 3. PRE HI-PASS FILTER

The parameter name is "Pre- HP". It filters out low frequency. Rotate the Data Knob to change the value. The range is 0 - 127.

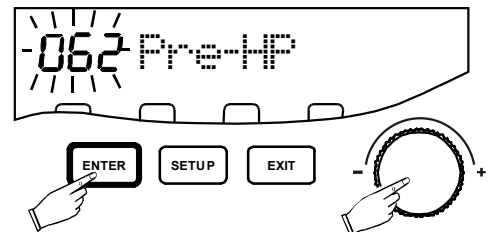

#### 4. TONE GAIN

The parameter name is "Tone Gain". It Decreases/ Increases sound brilliance.

Rotate the Data Knob to change the value. The range is 0 - 127. If it is < 64 then cut high frequency, > 64 then boost high frequency. 64=normal.

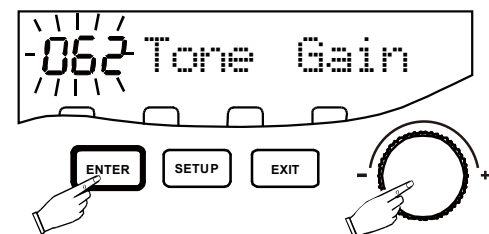

## SYSTEM SETUP

### USER CHORUS EFFECT

This function makes it possible to create your own Chorus effect. It'll be included in the Sound Effects List named UserChorus for your choice. 5 parameters for User Chorus setup are listed below.

The way of the setup is the same as User Reverb setup.

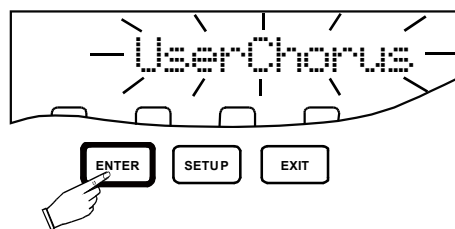

Parameter	Description	Data
Mode	Define Chorus effect Mode.	1=Chorus 2=Flanger 3=Tremolo 4=Phaser
Feedback	The chorus type effects have a feedback loop after the delay. Feeding back a small amount of the sound intensifies the effect.	0 - 127
Pre-HP	Pre Hi-pass filter. It filters out low frequency	0 - 127
LFO Rate	Low Frequency Oscillator (LFO) rate is applied as modulation rate. Higher is the rate, more intensive will be the effect.	0 - 127
Depth	Depth is the maximum amount of modulation applied to the delay.	0 - 127

### USER DELAY EFFECT

This function makes it possible to create your own Chorus effect. It'll be included in the Sound Effects List named UserChorus for your choice. 4 parameters for User Chorus setup are listed below.

The way of the setup is the same as User Reverb setup.

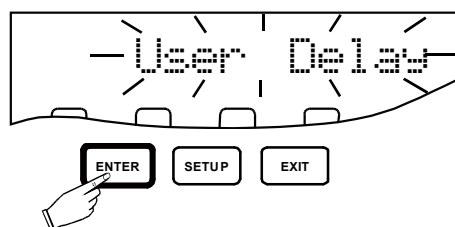

Parameter	Description	Data
Mode	Define the delay Mode.	1=Mono delay 2=Stereo delay
Delay Time	It determines the delay time. 0 represents 0 ms, 127 represents 1.3 seconds.	0 - 127
Feedback	Feeding back a small amount of the sound intensifies the effect.	0 - 127
Pre LP	Pre Low Frequency filter rate. Higher is the rate, more hi-frequency is filtered out.	0 - 127

## SYSTEM SETUP

### USER EQUALIZER

This function makes it possible to create your own 4-Band Parametric Equalizer. It'll be included in the Sound Effects List named User EQ for your choice. There are 4 parameters for User Equalizer setup listed below. The way of the setup is the same as User Reverb setup.

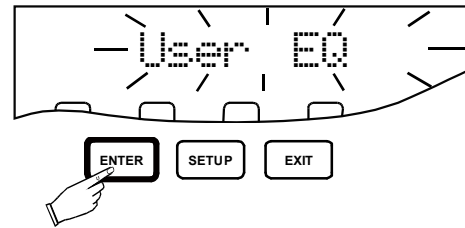

∴

Parameter	Description	Data
Gain Bass	Gain of the Bass band	0 - 127
Gain LowM	Gain of the Middle-Low band	0 - 127
Gain HighM	Gain of the Middle-High band	0 - 127
GainTreble	Gain of the Treble band	0 - 127

## RESET

After system setup, advanced edit, kit edit and phrase record, all of changes are saved in the unit. This feature allows you to recover the factory settings.

In the Kit select window, press the SETUP button. There are 4 modes can be selected. Rotate the Data knob until “Reset” appear then press the ENTER button to confirm.

Press the EXIT button or SETUP button again to exit and turn to the Kit selection window.

There are five Reset modes can be selected. When the reset mode name appears and blinks, rotate the Data Knob to select, then press the ENTER button to confirm. Or, press the EXIT button and back to the Reset window.

1. Reset Kits - Reset all kit configurations which changed during the kit editing.
2. Reset Adv - Reset all advanced edit which changed during the advanced editing.
3. Reset Sys - Reset all System Setup which changed during the System Setup.
4. Reset Phr - Erase all phrases recorded by user.
5. Reset All - Reset all items above.

Once a reset mode is confirmed by pressing the ENTER button, the display will show “Sure?”. Press the ENTER button to confirm. The reset processing needs couple of seconds while the display shows “Reset...”. After reset finished, it'll turn to the Kit window.

Or, press the EXIT button to cancel and it'll return to the Setup window.

 **Note:** Don not strike any pad and external instrument after press the ENTER button until it turns to the Kit window. During the reset processing, any button is disabled.

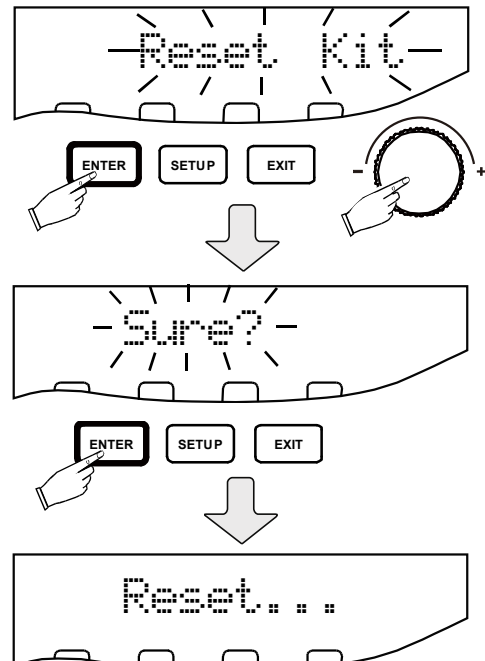
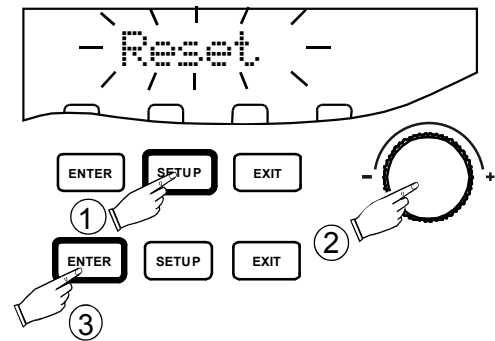



## MIDI & USB

MIDI stands for Musical Instrument Digital Interface. This is a world wide standard communication interface that enables electronic musical instruments and computers to communicate with each other so that instructions and other data can pass between them. This exchange of information makes it possible to create a system of MIDI instruments and devices that offers far greater versatility and control than is available with isolated instruments. Whether you interface with computers, sequencers, expanders or other equipment your musical horizons will be greatly enhanced. For instance, you can edit your playing in computer or playback MIDI song from computer while play the drum.

**USB** - The USB connector allows you to connect the drum directly to your computer. It can be connected without driver installation under the Windows XP, Windows Vista, Windows 7 & MAC OSx environment. The drum will be recognized as USB Audio device to receive and transmit the same MIDI messages described above.

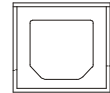

USB

### MIDI APPLICATION CHART

Function	Transmitted	Recognized	Remarks
Basic Channel	10	1-16	
Note Number	0-127	0-127	
Velocity: Note ON	1-127	0-127	
Note OFF	64	0-127	
Major Controls:			
B9h 04h xxh	Yes	X	Hi-Hat pedal control
Bxh 79h 00h	Yes	Yes	Reset All Controller
Bxh 7Bh 00h	Yes	Yes	All Notes OFF
Program Change	X	Yes *	
System Exclusive	Yes	Yes **	
RPN	X **	Yes **	
NRPN	Yes	Yes **	

\* Chanel 10 supports Bank 0 only

\*\* If you need detailed information about Exclusive, RPN and NRPN, please contact your vender

**Note:** Transmitted note through channel 10 are fixed as below:

### PAD

Pad	Layer A Note	Layer B Note	Pad	Layer A Note	Layer B Note
Pad 1	20	21	Pad 5	28	29
Pad 2	22	23	Pad 6	30	31
Pad 3	24	25	Pad 7	32	33
Pad 4	26	27	Pad 8	34	35

### EXTERNAL INSTRUMENT

Instrument	Note	Instrument	Note
Snare	38	Hi-Hat Open	46
Snare Rim1	37	Hi-Hat Close	42
Snare Rim2	40	Hi-Hat Pedal	44
Ride Head	51	Kick	36
Ride Edge	59	Ride Mute	6
Ride Bell	53		

## KIT LIST

Kit No.	Nkit Name	Default Layer Type							
		Pad 1	Pad 2	Pad 3	Pad 4	Pad 5	Pad 6	Pad 7	Pad 8
01	Standard	Off	Off	Off	Off	Off	Off	Off	Switch
02	Latin	Off	Off	Off	Off	Off	Off	Off	Off
03	Music FX	Off	Switch	Switch	Off	Off	Off	Switch	Off
04	Blues Mrmb	Off	Off	Off	Off	Off	Off	Off	Off
05	Arabian	Off	Off	Off	Off	Off	Off	Off	Off
06	Conga	Switch	Switch	Switch	Switch	Off	Off	Off	Switch
07	Tabla	Off	Off	Off	Off	Off	Off	Off	Off
08	Wood Block	Off	Off	Off	Off	Off	Off	Off	Off
09	FX Band	Off	Off	Off	Off	Off	Off	Off	Switch
10	Elc Shots	Off	Off	Off	Off	Off	Off	Off	Off
11	DJ Blues	Off	Off	Off	Off	Off	Off	Off	Off
12	SEV Drum	Switch	Off	Off	Off	Off	Switch	Off	Switch
13	Timpani	Off	Off	Off	Off	Off	Off	Off	Off
14	Elc World	Mix	Mix	Mix	Mix	Mix	Mix	Mix	Mix
15	CH Bell	Off	Off	Off	Off	Off	Off	Off	Off
16	CH Drum	Switch	Switch	Switch	Switch	Switch	Switch	Switch	Switch
17	Chinese	Off	Off	Off	Off	Off	Off	Off	Off
18	Hi Perc	Off	Off	Off	Off	Off	Off	Off	Off
19	Strings	Mix	Mix	Mix	Mix	Mix	Mix	Mix	Mix
20	CowBell	Off	Off	Off	Off	Off	Off	Off	Off
21	Bell Drum	Off	Off	Off	Off	Off	Off	Off	Off
22	Robot FX	Off	Off	Off	Off	Off	Off	Off	Off
23	War Crysis	Off	Off	Off	Off	Off	Off	Off	Off
24	SwingSwing	Off	Off	Off	Off	Off	Off	Off	Off
25	Pots	Switch	Switch	Switch	Switch	Off	Switch	Switch	Switch
26	Hits	Off	Off	Off	Off	Off	Off	Off	Off
27	Industry	Off	Off	Off	Off	Off	Off	Off	Off
28	Light Funk	Off	Off	Off	Off	Off	Off	Off	Off
29	Brass	Off	Off	Off	Off	Off	Off	Off	Off
30	Disco Beat	Off	Off	Off	Off	Off	Off	Off	Off
31	Church	Off	Off	Off	Off	Off	Off	Off	Off
32	Acoustic1	Off	Off	Off	Switch	Off	Off	Off	Switch
33	Acoustic2	Off	Off	Off	Switch	Off	Off	Off	Switch
34	Voice1	Off	Off	Off	Off	Off	Off	Off	Off
35	Voice2	Off	Off	Off	Off	Off	Off	Off	Off
36	Voice3	Off	Off	Off	Off	Off	Off	Off	Off
37	Sci-Voice1	Off	Off	Off	Off	Off	Off	Off	Off
38	Sci-Voice2	Off	Off	Off	Off	Off	Off	Off	Off
39	Machine	Off	Off	Off	Off	Off	Off	Off	Switch
40	RockBand	Off	Off	Off	Off	Off	Off	Off	Off

## KIT LIST

Kit No.	Nkit Name	Default Layer Type							
		Pad 1	Pad 2	Pad 3	Pad 4	Pad 5	Pad 6	Pad 7	Pad 8
41	Orchestra	Off	Off	Off	Off	Off	Off	Off	Off
42	Drama	Off	Off	Off	Off	Off	Off	Off	Off
43	Nature	Off	Off	Off	Off	Off	Off	Off	Off
44	Alien	Off	Off	Off	Off	Off	Switch	Switch	Switch
45	AC	Off	Off	Off	Off	Off	Off	Off	Off
46	Taiko	Off	Off	Off	Off	Off	Off	Off	Off
47	Bell	Off	Off	Off	Off	Mix	Mix	Mix	Mix
48	GUS	Mix	Mix	Mix	Mix	Off	Off	Off	Off
49	Ring1	Off	Off	Off	Off	Off	Off	Off	Off
50	Ring2	Off	Off	Off	Off	Off	Off	Off	Off
51	Ring3	Off	Off	Off	Off	Off	Off	Off	Off
52	Ring4	Off	Off	Off	Off	Off	Off	Off	Off
53	RevDrum1	Off	Off	Off	Off	Off	Off	Off	Off
54	RevDrum2	Off	Off	Off	Off	Off	Off	Off	Off
55	Balalaika	Off	Off	Off	Off	Off	Off	Off	Off
56	Tar	Off	Switch	Switch	Off	Switch	Off	Switch	Switch
57	Tropic	Off	Off	Off	Off	Off	Off	Off	Off
58	Perc FX	Switch	Switch	Switch	Switch	Off	Off	Switch	Switch
59	Funny	Off	Off	Off	Off	Off	Off	Off	Off
60	Kraski	Off	Off	Off	Off	Off	Switch	Switch	Off
61	Ceremony	Off	Off	Off	Off	Off	Off	Off	Off
62	Heavy Beat	Off	Off	Off	Off	Off	Off	Off	Off
63	Hi-Fi	Off	Off	Off	Off	Off	Off	Off	Off
64	Music Box	Off	Off	Off	Off	Off	Off	Off	Off
65	CH Opera1	Off	Off	Off	Off	Off	Off	Off	Off
66	CH Opera2	Off	Off	Off	Off	Off	Off	Off	Off
67	CH Opera3	Off	Off	Off	Off	Off	Off	Off	Off
68	CH Opera4	Off	Off	Off	Off	Off	Off	Off	Off
69	Sax	Off	Off	Off	Off	Off	Off	Off	Off
70	Mixed Kit1	Switch	Switch	Switch	Switch	Switch	Switch	Switch	Switch
71	Mixed Kit2	Switch	Switch	Switch	Switch	Switch	Switch	Switch	Switch
72	Mixed Kit3	Switch	Switch	Switch	Switch	Switch	Switch	Switch	Switch
73	Sci-Fic	Off	Off	Off	Off	Off	Off	Off	Off
74	Star Wars	Off	Off	Off	Off	Off	Off	Off	Off
75	Pop	Off	Off	Off	Off	Off	Off	Off	Off
76	Scratch	Off	Off	Off	Off	Off	Off	Off	Off
77	VOX	Off	Off	Off	Off	Off	Off	Off	Off
78	Lute1	Off	Off	Off	Off	Off	Off	Off	Off
79	Lute2	Off	Off	Off	Off	Off	Off	Off	Off
80	X-Mas	Off	Off	Off	Off	Off	Off	Off	Off

## GROOVEBOX & ACCOMPANIMENT LIST

### GrooveBox List

No.	GrooveBox	No.	GrooveBox
01	U got it	11	Synth
02	Hoy ti	12	Brothers
03	Smooth	13	Bossa
04	Waltz	14	Cici
05	Find	15	Stay
06	Carbon	16	The way
07	California	17	That's it
08	Let's rock	18	Games
09	Pop ballad	19	Step
10	Slapin	20	Mixer

### Accompaniment List

No.	Accompaniment	No.	Accompaniment
01	Bottle	11	Month
02	Bowdown	12	Sunshine
03	Freemind	13	Vida
04	Remcele	14	Mayday
05	Smile	15	Being
06	Soft	16	Case
07	Wish	17	Marie
08	Binary	18	Myeyes
09	Carryout	19	Sea
10	Challenge	20	Spud

## SOUND EFFECTS LIST

### Reverb Type List

No.	Description	Display	No.	Description	Display
01	Short Room A	ShortRoomA	15	Gated Reverb A	Gated RevA
02	Short Room B	ShortRoomB	16	Gated Reverb B	Gated RevB
03	Short Room C	ShortRoomC	17	Gated Plate A	Gtd PlateA
04	Room A	Room A	18	Gated Plate B	Gtd PlateB
05	Room B	Room B	19	Mono Echo	Mono Echo
06	Small Hall A	SmallHallA	20	Stereo Echo	StereoEcho
07	Small Hall B	SmallHallB	21	Mono 3/4 Echo	M.Echo 3/4
08	Large Hall A	LargeHallA	22	Stereo 3/4 Echo	S.Echo 3/4
09	Large Hall B	LargeHallB	23	Mono 4/4 Echo	M,Echo 4/4
10	Short Plate	ShortPlate	24	Stereo 4/4 Echo	S.Echo 4/4
11	Vocal Plate	VocalPlate	25	Mono Triplet Echo	M.Echo Tri
12	Church A	Church A	26	Stereo Triplet Echo	S.Echo Tri
13	Church B	Church B	27	User Veverb	UserReverb
14	Cathedral	Cathedral			

### Chorus Type List

No.	Description	Display	No.	Description	Display
01	Chorus Li ght 1	Lt.Chorus1	13	Flange Slow Deep	Slw Flange
02	Chorus Light 2	Lt.Chorus2	14	Flange Deep	Dp.Flange
03	Chorus Medium 1	Md.Chorus1	15	Phaser Light	Lt.Phaser
04	Chorus Medium 2	Md.Chorus2	16	Phaser Medium	Md.Phaser
05	Chorus Deep 1	Dp.Chorus1	17	Phaser Slow Deep	Slw Phaser
06	Chorus Deep 2	Dp.Chorus2	18	Phaser Fast	Fst.Phaser
07	Chorus Fast 1	FstChorus1	19	Tremolo Slow	SlwTremolo
08	Chorus Fast 2	FstChorus2	20	Tremolo Medium 1	Md.Tremlo1
09	Resonant Chorus	Res.Chorus	21	Tremolo Medium 2	Md.Tremlo2
10	Long Time Chorus	LT.Chorus	22	Tremolo Fast	Fst.Tremlo
11	Flange Light	Lt.Flange	23	User Chorus	UserChorus
12	Flange Medium	Md.Flange			

### Delay Type List

No..	Description	Display	No.	Description	Display
01	Delay 1	Delay 1	04	Delay 4	Delay 4
02	Delay 2	Delay 2	05	User Delay	User Delay
03	Delay 3	Delay 3			

### Equalizer Type List

No.	Equalizer Type	No.	Equalizer Type
01	Normal 1	06	Bright Mid
02	Normal 2	07	Bright
03	Bass Boost	08	Bright High
04	Bass Mid	09	User EQ
05	Moderate		

## VOICE LIST

### INDEX

Category	Voice Number
GM Bank	1-61
Kick	397-423
Hi-Hat	346-367
Cymbal	225-231
Snare	726-758
Side-Stick	723-725
Floor Tom	833-842
Low Mid Tom	843-847
High Mid Tom	829-832
High Tom	826-828
Percussion Effect	117-119, 187-192, 380-392, 485-530, 707-710
Hand Drum	66-79, 324-328, 393-396
Banya	61-63
Tabla	779-791
Timpani	792-825
Voice	232-239 851-892
Animal Sound	62-65
Bell	108-116, 123-134, 208-219, 329-345, 765-778
Marimba	447-484
Brass	135-146
Bowl	120-122
Pot	694-706
Wood Block	893-914
Triangle	848-850
Cowbell	193-207
Craski	220-224
Balalaika	80-104
Guitar	310-323
Lute	424-446
Chinese Instrument	147-186
Hits	368-379
Special FX	759-764
Scratch	711-722
Effect	240-309
Other Percussions	531-693

## VOICE LIST

No.	Name	No.	Name	No.	Name	No.	Name
001	HighQ	041	HighAgogo	081	Balalaik02	121	Bowl2
002	Slap	042	LowAgogo	082	Balalaik03	122	Bowl3
003	ScraPush	043	Cabasa	083	Balalaik04	123	BP01
004	ScraPull	044	Maracas	084	Balalaik05	124	BP02
005	Stick	045	ShortWhist	085	Balalaik06	125	BP03
006	SquarClick	046	LongWhist	086	Balalaik07	126	BP04
007	MetroClick	047	ShortGuiro	087	Balalaik08	127	BP05
008	MetroBell	048	LongGuiro	088	Balalaik09	128	BP06
009	KickDrum2	049	Claves	089	Balalaik10	129	BP07
010	KickDrum1	050	Hi W-Block	090	Balalaik11	130	BP08
011	SideStick	051	Lo W-Block	091	Balalaik12	131	BP09
012	SnareDrum2	052	MuteCuica	092	Balalaik13	132	BP10
013	HandClap	053	OpenCuica	093	Balalaik14	133	BP11
014	SnareDrum1	054	MuteTriang	094	Balalaik15	134	BP12
015	LoFloTom2	055	OpenTriang	095	Balalaik16	135	Brass01
016	CloseHH	056	Cabasa	096	Balalaik17	136	Brass02
017	LowFloTom1	057	Shaker	097	Balalaik18	137	Brass03
018	PedalHH	058	Belltree	098	Balalaik19	138	Brass04
019	LowTom	059	Castanets	099	Balalaik20	139	Brass05
020	OpenHi-hat	060	MuteSurdo	100	Balalaik21	140	Brass06
021	Low-midTom	061	OpenSurdo	101	Balalaik22	141	Brass07
022	Hi-midTom	062	Animal1	102	Balalaik23	142	Brass08
023	CrashCymb1	063	Animal2	103	Balalaik24	143	Brass09
024	RHighTom	064	Animal3	104	Balalaik25	144	Brass10
025	RideCymb1	065	Animal4	105	Banya1	145	Brass11
026	ChCymbal	066	Arabian1	106	Banya2	146	Brass12
027	RideBell	067	Arabian2	107	Banya3	147	Chinese01
028	Tambourine	068	Arabian3	108	Bell1	148	Chinese02
029	SplashCymb	069	Arabian4	109	Bell2	149	Chinese03
030	Cowbell	070	Arabian5	110	Bell3	150	Chinese04
031	CrashCymb2	071	Arabian6	111	Bell4	151	Chinese05
032	VibraSlap	072	Arabian7	112	Bell5	152	Chinese06
033	RideCymb2	073	Athlp1	113	Bell6	153	Chinese07
034	HiBongo	074	Athlp2	114	Bell7	154	Chinese08
035	LowBongo	075	Athlp3	115	Bell8	155	Chinese09
036	MuteConga	076	Atht1	116	Bell9	156	Chinese10
037	HiConga	077	Atht2	117	Bktk1	157	Chinese11
038	LowConga	078	Atht3	118	Bktk2	158	Chinese12
039	HighTimbal	079	Atht4	119	Bktk3	159	Chinese13
040	LowTimbale	080	Balalaik01	120	Bowl1	160	Chinese14

## VOICE LIST

Name	No.	Name	No.	Name	No.	Name
Chinese15	201	Cowbell09	241	Effects02	281	Effects42
Chinese16	202	Cowbell10	242	Effects03	282	Effects43
Chinese17	203	Cowbell11	243	Effects04	283	Effects44
Chinese18	204	Cowbell12	244	Effects05	284	Effects45
Chinese19	205	Cowbell13	245	Effects06	285	Effects46
Chinese20	206	Cowbell14	246	Effects07	286	Effects47
Chinese21	207	Cowbell15	247	Effects08	287	Effects48
Chinese22	208	CR01	248	Effects09	288	Effects49
Chinese23	209	CR02	249	Effects10	289	Effects50
Chinese24	210	CR03	250	Effects11	290	Effects51
Chinese25	211	CR04	251	Effects12	291	Effects52
Chinese26	212	CR05	252	Effects13	292	Effects53
Chinese27	213	CR06	253	Effects14	293	Effects54
Chinese28	214	CR07	254	Effects15	294	Effects55
Chinese29	215	CR08	255	Effects16	295	Effects56
Chinese30	216	CR09	256	Effects17	296	Effects57
Chinese31	217	CR10	257	Effects18	297	Effects58
Chinese32	218	CR11	258	Effects19	298	Effects59
Chinese33	219	CR12	259	Effects20	299	Effects60
Chinese34	220	Craski1	260	Effects21	300	Effects61
Chinese35	221	Craski2	261	Effects22	301	Effects62
Chinese36	222	Craski3	262	Effects23	302	Effects63
Chinese37	223	Craski4	263	Effects24	303	Effects64
Chinese38	224	Craski5	264	Effects25	304	Effects65
Chinese39	225	Cymbal01	265	Effects26	305	Effects66
Chinese40	226	Cymbal02	266	Effects27	306	Gtr1
Ckjk1	227	Cymbal03	267	Effects28	307	Gtr2
Ckjk2	228	Cymbal04	268	Effects29	308	Gtr3
Ckjk3	229	Cymbal05	269	Effects30	309	Gtr4
Ckjk4	230	Cymbal06	270	Effects31	310	Gus01
Ckjk5	231	Cymbal07	271	Effects32	311	Gus02
Ckjk6	232	Dine1	272	Effects33	312	Gus03
Cowbell01	233	Dine2	273	Effects34	313	Gus04
Cowbell02	234	Dine3	274	Effects35	314	Gus05
Cowbell03	235	Dine4	275	Effects36	315	Gus06
Cowbell04	236	Dine5	276	Effects37	316	Gus07
Cowbell05	237	Dine6	277	Effects38	317	Gus08
Cowbell06	238	Dine7	278	Effects39	318	Gus09
Cowbell07	239	Dine8	279	Effects40	319	Gus10
Cowbell08	240	Effects01	280	Effects41	320	Gus11



## VOICE LIST

No.	Name	No.	Name	No.	Name	No.	Name
321	Gus12	361	Hi-hat16	401	Kick05	441	Lute18
322	Gus13	362	Hi-hat17	402	Kick06	442	Lute19
323	Gus14	363	Hi-hat18	403	Kick07	443	Lute20
324	Handpan1	364	Hi-hat19	404	Kick08	444	Lute21
325	Handpan2	365	Hi-hat20	405	Kick09	445	Lute22
326	Handpan3	366	Hi-hat21	406	Kick10	446	Lute23
327	Handpan4	367	Hi-hat22	407	Kick11	447	Marimba01
328	Handpan5	368	Hit01	408	Kick12	448	Marimba02
329	HEA01	369	Hit02	409	Kick13	449	Marimba03
330	HEA02	370	Hit03	410	Kick14	450	Marimba04
331	HEA03	371	Hit04	411	Kick15	451	Marimba05
332	HEA04	372	Hit05	412	Kick16	452	Marimba06
333	HEA05	373	Hit06	413	Kick17	453	Marimba07
334	HEA06	374	Hit07	414	Kick18	454	Marimba08
335	HEA07	375	Hit08	415	Kick19	455	Marimba09
336	HEA08	376	Hit09	416	Kick20	456	Marimba10
337	HEA09	377	Hit10	417	Kick21	457	Marimba11
338	HEA10	378	Hit11	418	Kick22	458	Marimba12
339	HEA11	379	Hit12	419	Kick23	459	Marimba13
340	HEA12	380	HMN01	420	Kick24	460	Marimba14
341	HEA13	381	HMN02	421	Kick25	461	Marimba15
342	HEA14	382	HMN03	422	Kick26	462	Marimba16
343	HEA15	383	HMN04	423	Kick27	463	Marimba17
344	HEA16	384	HMN05	424	Lute01	464	Marimba18
345	HEA17	385	HMN06	425	Lute02	465	Marimba19
346	Hi-hat01	386	HMN07	426	Lute03	466	Marimba20
347	Hi-hat02	387	HMN08	427	Lute04	467	Marimba21
348	Hi-hat03	388	HMN09	428	Lute05	468	Marimba22
349	Hi-hat04	389	HMN10	429	Lute06	469	Marimba23
350	Hi-hat05	390	HMN11	430	Lute07	470	Marimba24
351	Hi-hat06	391	HMN12	431	Lute08	471	Marimba25
352	Hi-hat07	392	HMN13	432	Lute09	472	Marimba26
353	Hi-hat08	393	Indian1	433	Lute10	473	Marimba27
354	Hi-hat09	394	Indian2	434	Lute11	474	Marimba28
355	Hi-hat10	395	Indian3	435	Lute12	475	Marimba29
356	Hi-hat11	396	Indian4	436	Lute13	476	Marimba30
357	Hi-hat12	397	Kick01	437	Lute14	477	Marimba31
358	Hi-hat13	398	Kick02	438	Lute15	478	Marimba32
359	Hi-hat14	399	Kick03	439	Lute16	479	Marimba33
360	Hi-hat15	400	Kick04	440	Lute17	480	Marimba34

## VOICE LIST

No.	Name	No.	Name	No.	Name	No.	Name
481	Marimba35	521	Perc Fx30	561	Perc031	601	Perc071
482	Marimba36	522	Perc Fx31	562	Perc032	602	Perc072
483	Marimba37	523	Perc Fx32	563	Perc033	603	Perc073
484	Marimba38	524	Perc Fx33	564	Perc034	604	Perc074
485	Mtl1	525	Perc Fx34	565	Perc035	605	Perc075
486	Mtl2	526	Perc Fx35	566	Perc036	606	Perc076
487	Mtl3	527	Perc Fx36	567	Perc037	607	Perc077
488	Mtl4	528	Perc Fx37	568	Perc038	608	Perc078
489	Mtl5	529	Perc Fx38	569	Perc039	609	Perc079
490	Mtl6	530	Perc Fx39	570	Perc040	610	Perc080
491	Mtl7	531	Perc001	571	Perc041	611	Perc081
492	Perc Fx01	532	Perc002	572	Perc042	612	Perc082
493	Perc Fx02	533	Perc003	573	Perc043	613	Perc083
494	Perc Fx03	534	Perc004	574	Perc044	614	Perc084
495	Perc Fx04	535	Perc005	575	Perc045	615	Perc085
496	Perc Fx05	536	Perc006	576	Perc046	616	Perc086
497	Perc Fx06	537	Perc007	577	Perc047	617	Perc087
498	Perc Fx07	538	Perc008	578	Perc048	618	Perc088
499	Perc Fx08	539	Perc009	579	Perc049	619	Perc089
500	Perc Fx09	540	Perc010	580	Perc050	620	Perc090
501	Perc Fx10	541	Perc011	581	Perc051	621	Perc091
502	Perc Fx11	542	Perc012	582	Perc052	622	Perc092
503	Perc Fx12	543	Perc013	583	Perc053	623	Perc093
504	Perc Fx13	544	Perc014	584	Perc054	624	Perc094
505	Perc Fx14	545	Perc015	585	Perc055	625	Perc095
506	Perc Fx15	546	Perc016	586	Perc056	626	Perc096
507	Perc Fx16	547	Perc017	587	Perc057	627	Perc097
508	Perc Fx17	548	Perc018	588	Perc058	628	Perc098
509	Perc Fx18	549	Perc019	589	Perc059	629	Perc099
510	Perc Fx19	550	Perc020	590	Perc060	630	Perc100
511	Perc Fx20	551	Perc021	591	Perc061	631	Perc101
512	Perc Fx21	552	Perc022	592	Perc062	632	Perc102
513	Perc Fx22	553	Perc023	593	Perc063	633	Perc103
514	Perc Fx23	554	Perc024	594	Perc064	634	Perc104
515	Perc Fx24	555	Perc025	595	Perc065	635	Perc105
516	Perc Fx25	556	Perc026	596	Perc066	636	Perc106
517	Perc Fx26	557	Perc027	597	Perc067	637	Perc107
518	Perc Fx27	558	Perc028	598	Perc068	638	Perc108
519	Perc Fx28	559	Perc029	599	Perc069	639	Perc109
520	Perc Fx29	560	Perc030	600	Perc070	640	Perc110

## VOICE LIST

No.	Name	No.	Name	No.	Name	No.	Name
641	Perc111	681	Perc151	721	Scratch11	761	Spec FX3
642	Perc112	682	Perc152	722	Scratch12	762	Spec FX4
643	Perc113	683	Perc153	723	S-Stick01	763	Spec FX5
644	Perc114	684	Perc154	724	S-Stick02	764	Spec FX6
645	Perc115	685	Perc155	725	S-Stick03	765	SPH01
646	Perc116	686	Perc156	726	Snare01	766	SPH02
647	Perc117	687	Perc157	727	Snare02	767	SPH03
648	Perc118	688	Perc158	728	Snare03	768	SPH04
649	Perc119	689	Perc159	729	Snare04	769	SPH05
650	Perc120	690	Perc160	730	Snare05	770	SPH06
651	Perc121	691	Perc161	731	Snare06	771	SPH07
652	Perc122	692	Perc162	732	Snare07	772	SPH08
653	Perc123	693	Perc163	733	Snare08	773	SPH09
654	Perc124	694	Pot01	734	Snare09	774	SPH10
655	Perc125	695	Pot02	735	Snare10	775	SPH11
656	Perc126	696	Pot03	736	Snare11	776	SPH12
657	Perc127	697	Pot04	737	Snare12	777	SPH13
658	Perc128	698	Pot05	738	Snare13	778	SPH14
659	Perc129	699	Pot06	739	Snare14	779	Tabla01
660	Perc130	700	Pot07	740	Snare15	780	Tabla02
661	Perc131	701	Pot08	741	Snare16	781	Tabla03
662	Perc132	702	Pot09	742	Snare17	782	Tabla04
663	Perc133	703	Pot10	743	Snare18	783	Tabla05
664	Perc134	704	Pot11	744	Snare19	784	Tabla06
665	Perc135	705	Pot12	745	Snare20	785	Tabla07
666	Perc136	706	Pot13	746	Snare21	786	Tabla08
667	Perc137	707	Pswc1	747	Snare22	787	Tabla09
668	Perc138	708	Pswc2	748	Snare23	788	Tabla10
669	Perc139	709	Pswc3	749	Snare24	789	Tabla11
670	Perc140	710	Pswc4	750	Snare25	790	Tabla12
671	Perc141	711	Scratch01	751	Snare26	791	Tabla13
672	Perc142	712	Scratch02	752	Snare27	792	THH01
673	Perc143	713	Scratch03	753	Snare28	793	THH02
674	Perc144	714	Scratch04	754	Snare29	794	THH03
675	Perc145	715	Scratch05	755	Snare30	795	THH04
676	Perc146	716	Scratch06	756	Snare31	796	THH05
677	Perc147	717	Scratch07	757	Snare32	797	THH06
678	Perc148	718	Scratch08	758	Snare33	798	THH07
679	Perc149	719	Scratch09	759	Spec FX1	799	THH08
680	Perc150	720	Scratch10	760	Spec FX2	800	THH09

## VOICE LIST

No.	Name	No.	Name	No.	Name	No.	Name
801	THH10	831	Tom-HiMid3	861	Voice11	891	Voice41
802	THH11	832	Tom-HiMid4	862	Voice12	892	Voice42
803	THH12	833	Tom-Lo1	863	Voice13	893	W-Block01
804	THH13	834	Tom-Lo2	864	Voice14	894	W-Block02
805	Tima1	835	Tom-Lo3	865	Voice15	895	W-Block03
806	Tima2	836	Tom-Lo4	866	Voice16	896	W-Block04
807	Timpani01	837	Tom-Lo5	867	Voice17	897	W-Block05
808	Timpani02	838	Tom-Lo6	868	Voice18	898	W-Block06
809	Timpani03	839	Tom-Lo6	869	Voice19	899	W-Block07
810	Timpani04	840	Tom-Lo7	870	Voice20	900	W-Block08
811	Timpani05	841	Tom-Lo8	871	Voice21	901	W-Block09
812	Timpani06	842	Tom-Lo9	872	Voice22	902	W-Block10
813	Timpani07	843	Tom-LoMid1	873	Voice23	903	W-Block11
814	Timpani08	844	Tom-LoMid2	874	Voice24	904	W-Block12
815	Timpani09	845	Tom-LoMid3	875	Voice25	905	W-Block13
816	Timpani10	846	Tom-LoMid4	876	Voice26	906	W-Block14
817	Timpani11	847	Tom-LoMid4	877	Voice27	907	W-Block15
818	Timpani12	848	Triangle1	878	Voice28	908	W-Block16
819	Timpani13	849	Triangle2	879	Voice29	909	W-Block17
820	Timpani14	850	Triangle3	880	Voice30	910	W-Block18
821	Timpani15	851	Voice01	881	Voice31	911	W-Block19
822	Timpani16	852	Voice02	882	Voice32	912	W-Block20
823	Timpani17	853	Voice03	883	Voice33	913	W-Block21
824	Timpani18	854	Voice04	884	Voice34	914	W-Block22
825	Timpani19	855	Voice05	885	Voice35		
826	Tom-Hi1	856	Voice06	886	Voice36		
827	Tom-Hi2	857	Voice07	887	Voice37		
828	Tom-Hi3	858	Voice08	888	Voice38		
829	Tom-HiMid1	859	Voice09	889	Voice39		
830	Tom-HiMid2	860	Voice10	890	Voice40		

## SPECIFICATIONS

Built-in Pad	8 built-in pads with velocity response and layer feature
External Trigger	Snare drum, Kick drum, Ride cymbal, Hi-Hat cymbal and Hi-Hat pedal
Voice	914
Drum Kit	80 Editable pad kits, 5 Editable external instrument kits,
Layer Type	Switch, Mix, Fade, X.Fade, Off
GrooveBox	20 preset styles composed of drum kit beat and other instrument obligato, effect sound and sequential notes
Sound Effect	Reverb, Chorus and Delay in professional DSP processor
Equalizer	8 preset types
Metronome	Volume, Tempo, Beat
Controls	Phone Volume and Master Volume knobs, Kit, Play/Stop, Record, G.Box, Click, Phrase, Setup, Enter and Exit buttons, Data Knob
Kit Edit	Voice, Volume, Pan, Pitch, Effect, Layer, Reset, External triggering
Advanced Edit	Sensitivity, Headroom, Crosstalk, Mask Time, Triggering curve
System Setup	Chain assignment, Master Volume, Master tune, Equalizer, Foot switch pedal, Local, Phrase play mode, User effects and Equalizer
Reset	Reset Kits, Advanced edit, Phrases and Reset all
Phrase	30 User phrase, 20 built-in Accompaniments, Over write and Over Dubbing record mode, Record setup, Edit, Save, Playback, Erase,
Display	Custom back-light LCD
Power	9V DC
Connection	Headphone, Line Out (L/Mono, R), Line in, USB, MIDI In/Out, Foot Switch, External Trigger Input X 5, Power In
Dimensions	541 (W) X 332 (D) X 96 (H) mm

All specifications and appearances are subject to change without notice



# HDP-1 DIGITAL DRUM

## USER'S MANUAL

Shanghai Huaxin Musical Instrument Co., Ltd.  
35 Lao Shan Yi Cun  
Shanghai 200120  
China  
Tel: +86-21-58820000  
Fax: +86-21-58783113  
Email: [huaxin@huaxin-music.com](mailto:huaxin@huaxin-music.com)  
[www.huaxin-music.com](http://www.huaxin-music.com)

Rev. 1.02